

RICHARD WIMMER N1B

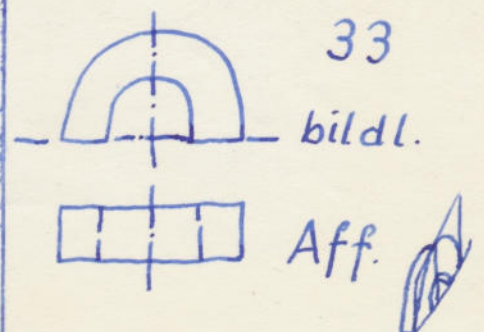
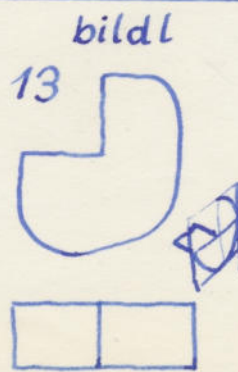
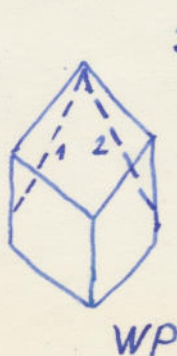
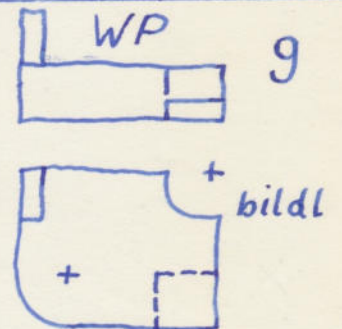
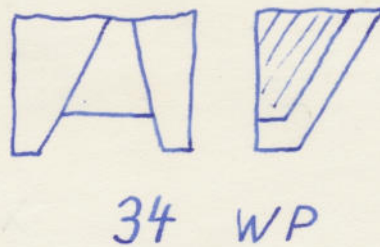
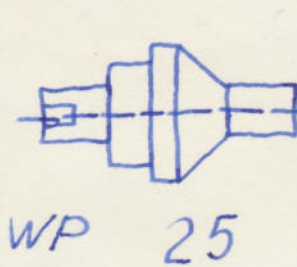
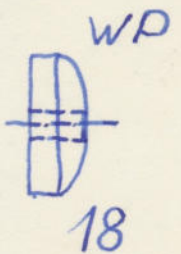
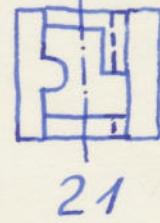
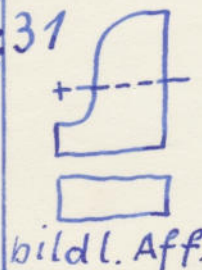
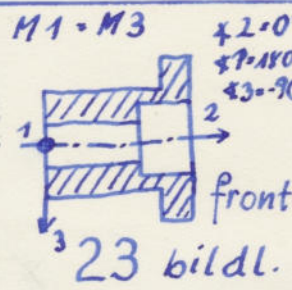
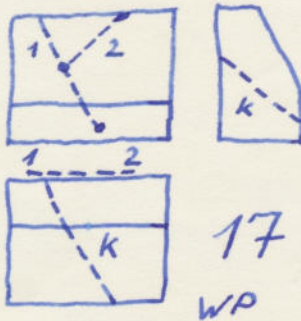
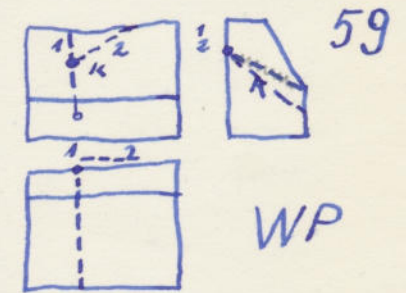
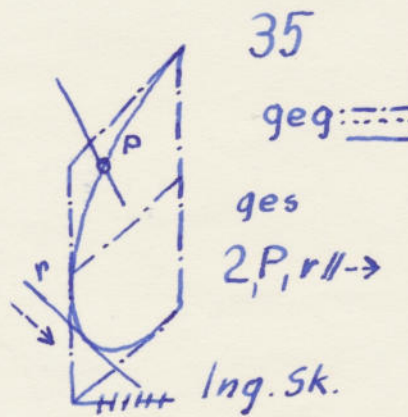
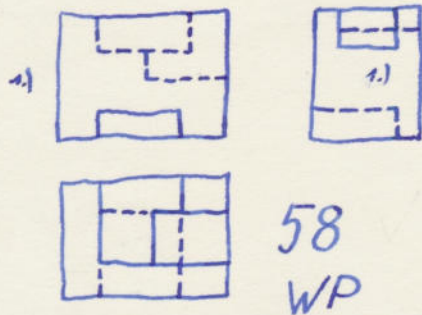
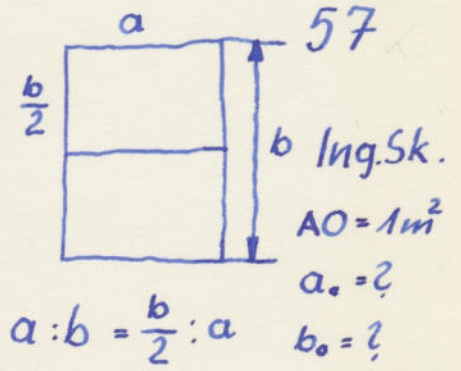
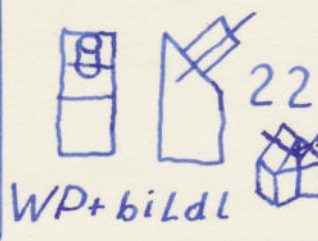
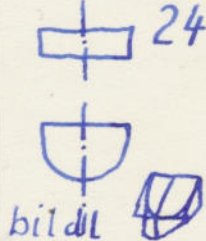
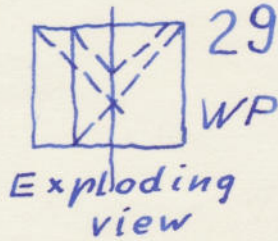
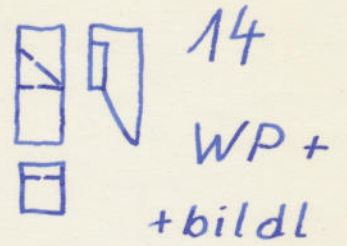
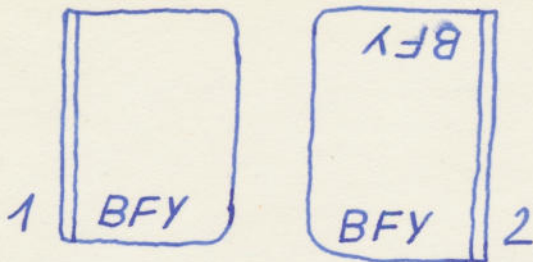

RICHARD WIMMER

N1/B

ICH BIN DIE KUNST DES FREUDIGEN  
DENKENS, DES SCHAUENS, DIE  
KUNST DER WISSENSCHAFT, DIE  
KUNST DES ORDNENS, DIE KUNST  
DES SCHÖNEN FÜGENS UND DER  
GESCHICKLICHKEIT. ICH BIN DER  
BESITZ DES ALLHERRSCHERS VON  
EWIGKEIT HER, NOCH BEVOR ALLES  
WARD. UND DAS WAR MEINE  
FREUDE. ICH SPIELTE MIT DEN DINGEN  
ALLEN DIE GESCHAFFEN WURDEN  
UND ORDNETE ALLE UND MEINE  
FREUDE IST ES, WENN IHR  
MENSCHEN MIT MIR ZUSAMMEN  
SPIELT UND FÜGT-WIE ICH ES TUE.  
DANN WERDET IHR MEISTER

24

WERDEN UND IMMER NEUES LEBEN  
STRÖMT EUCH ZU UND REINE  
SCHÖNHET SEHT IHR.

KUNST DER WISSENSCHAFT, DIE  
KUNST DES ORDINENS, DIE KUNST  
DES SCHÖNEN FÜGENS UND DER  
GESCHICKLICHKEIT ICH BIN DER  
BESITZ DES ATHERRSCHERS VON  
EWIGKEIT HER, NOCH BEVOR ALLES  
WARD. UND DAS WAR MEINE  
FREIHEIT ICH SPIELTE MIT DEN DINGEN  
ALLEN DIE GESCHAFFEN WAREN  
UND KUNDE ALLE KUNSTEN  
FREIHEIT IS DAS VORNEHMEN  
WENIGER MIT WENIGER ZUSAMMEN  
SPHÄRE MIT ETWAS FÜR SICH ES IST  
DANN VERFÜRTE SICH DER SEIN

7

o a b c d g p p n h m r u i x y

z v w k y  $f = 1 + \overset{\circ}{+} - = f$   $\beta = 1 + 3 = \beta$

t = t l = l s = c + s u = l + j + u = u

e = c + \overset{\circ}{+} - l + \gamma = n

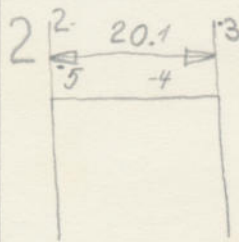
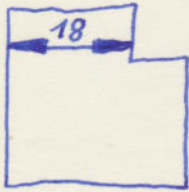
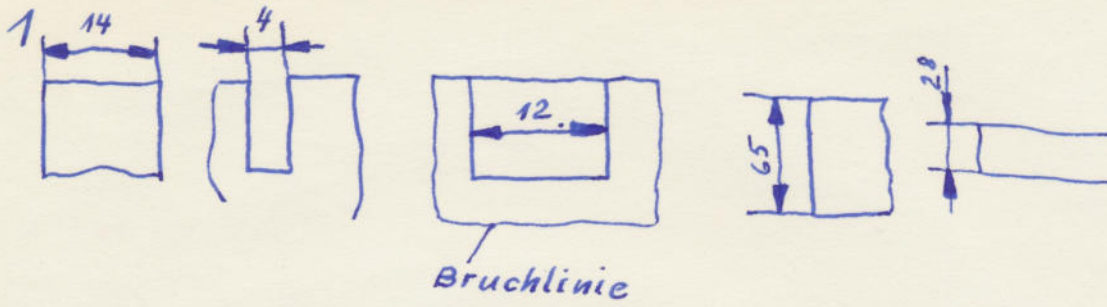

1: ~ 1mm  
 2: 2,5 ÷ 3mm  
 3: 2mm  
 4: min 5mm

} gleichbl.

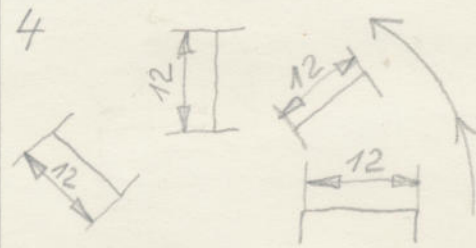
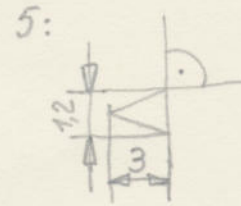

• mögl. vermeiden

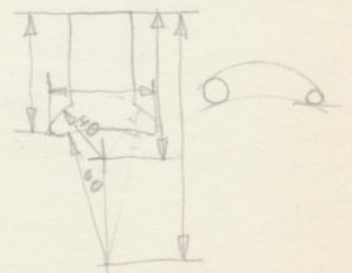
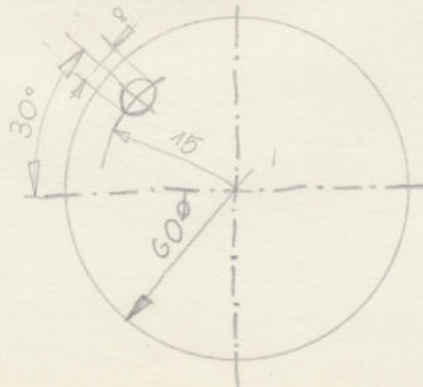
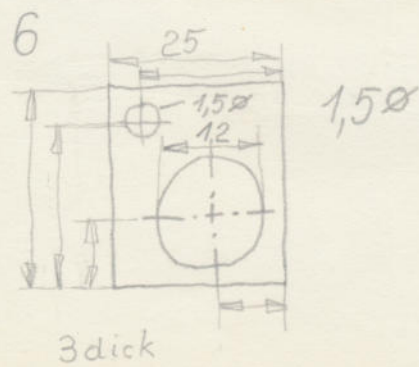
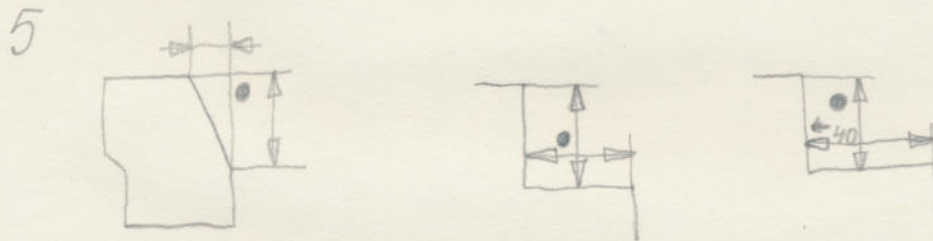

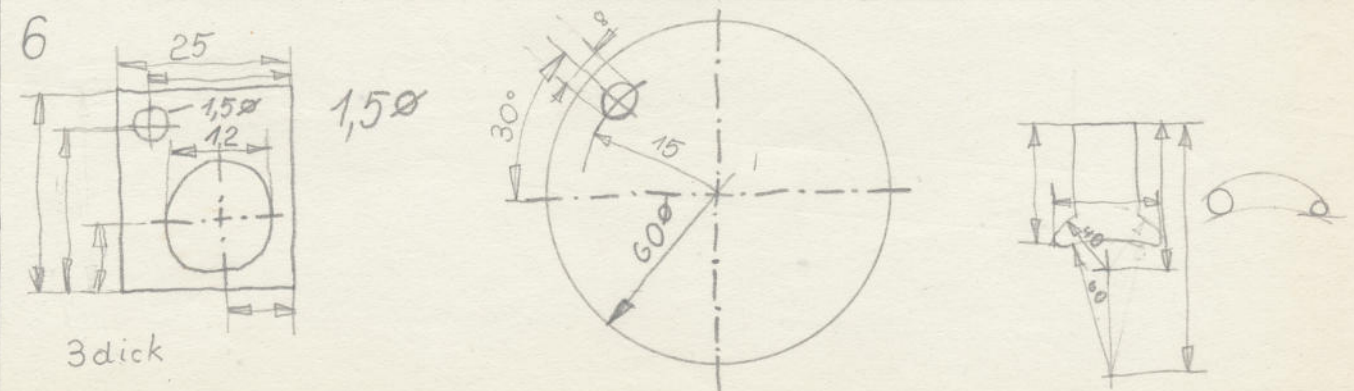
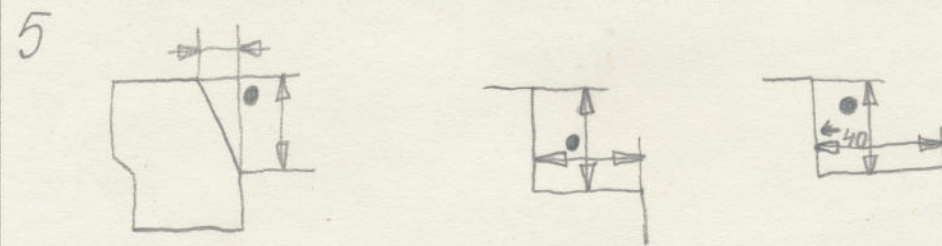
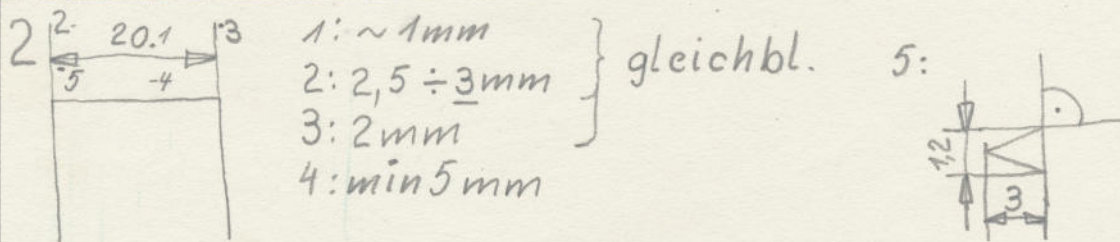
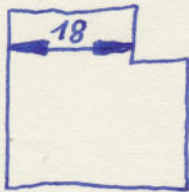
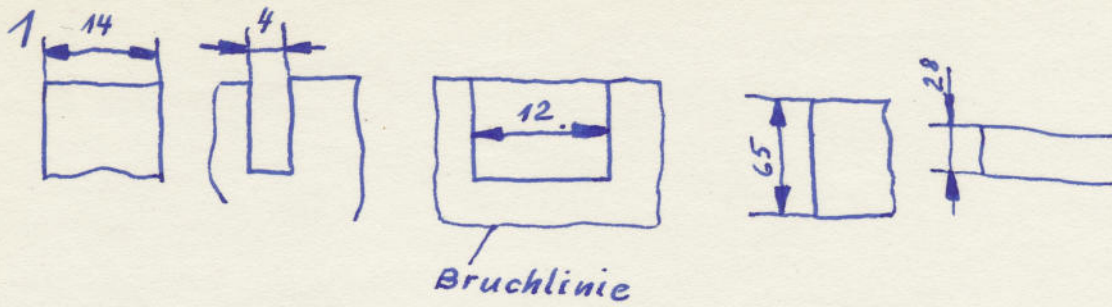

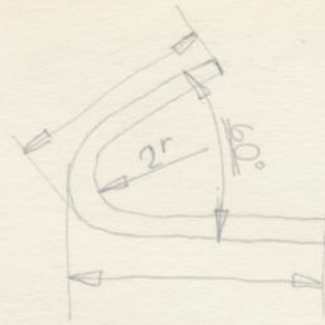
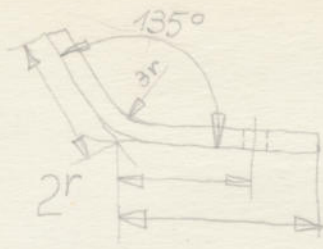
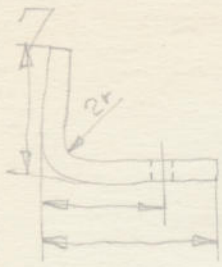

8

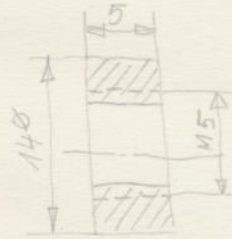
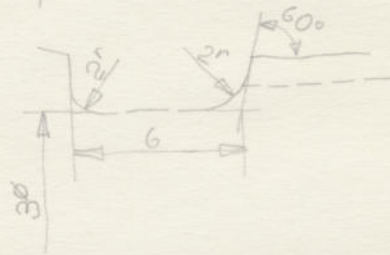

9

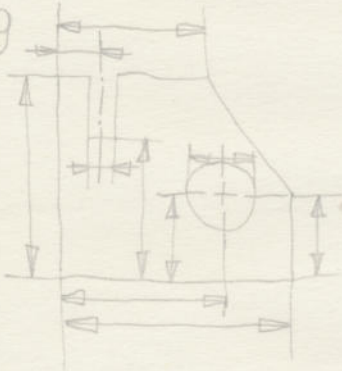

Ergänzung zu 6

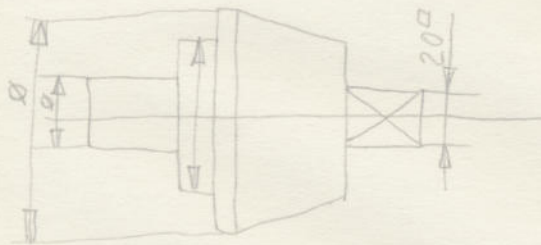

20□





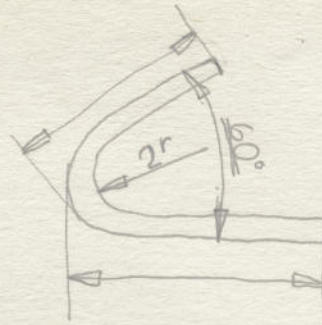
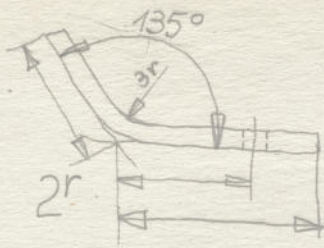
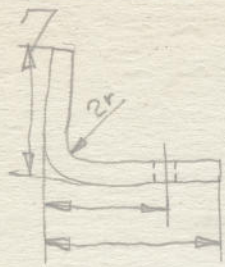

8

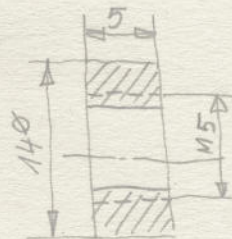
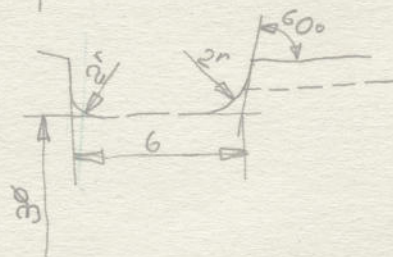
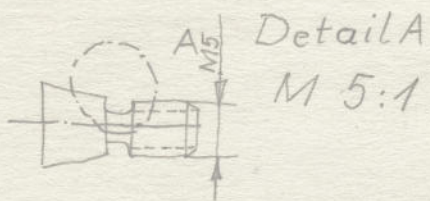

9

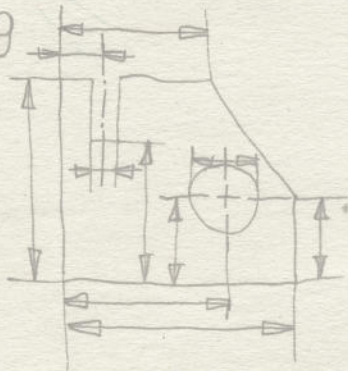

Ergänzung zu 6

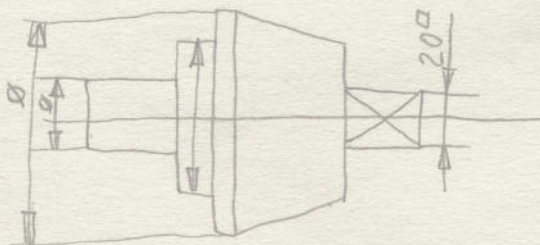

20<sup>□</sup>

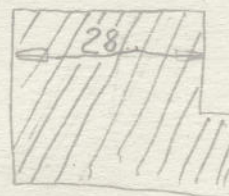

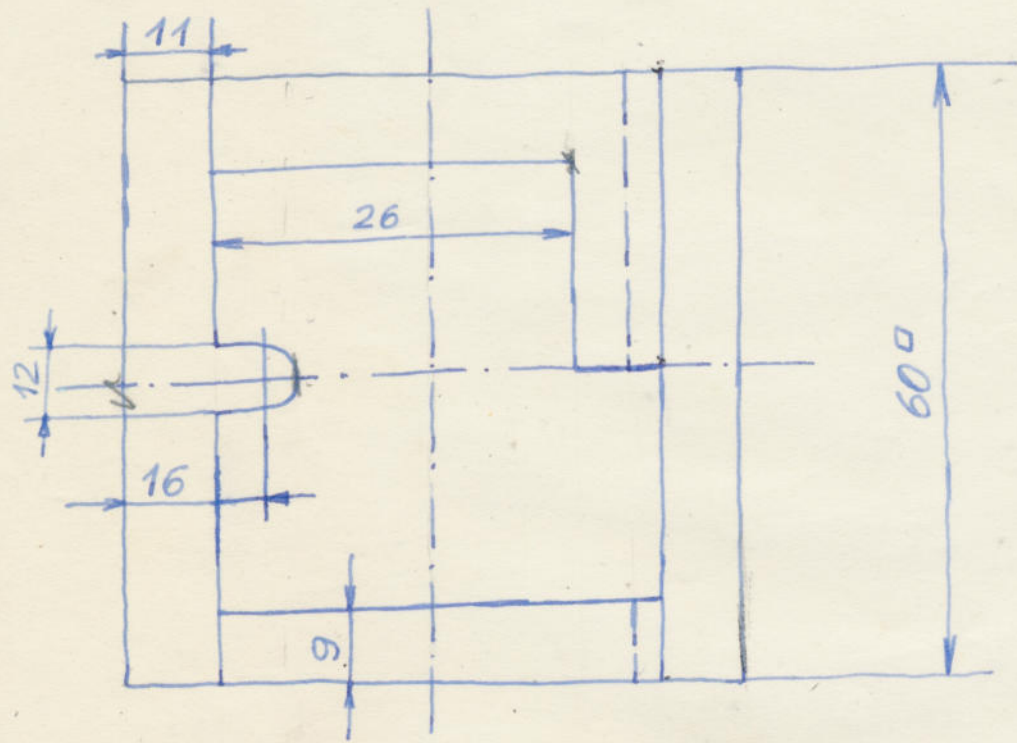
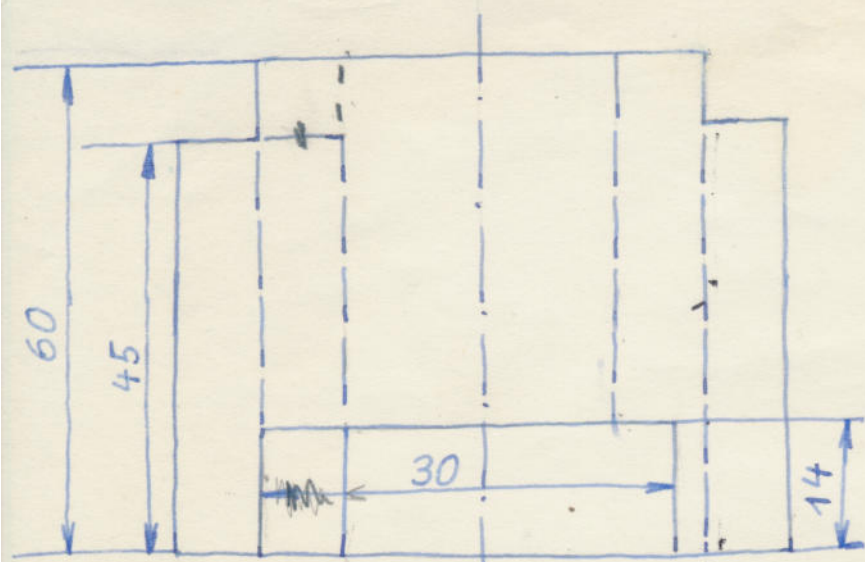

*Handwritten signature*

RICHARD WIMMER N 1B

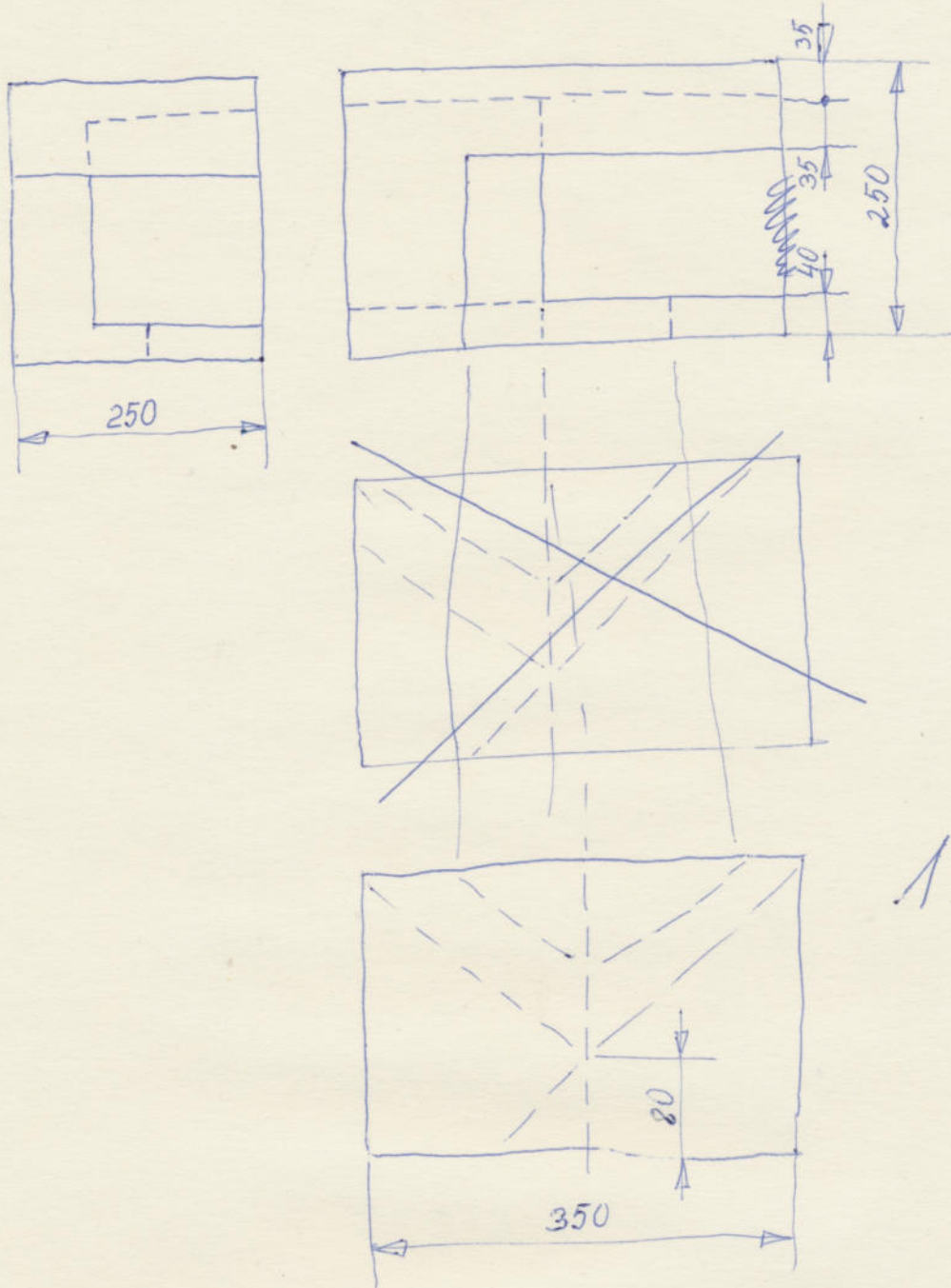

1:5

Wimmer

h

RICHARD WIMMER

N 1/B

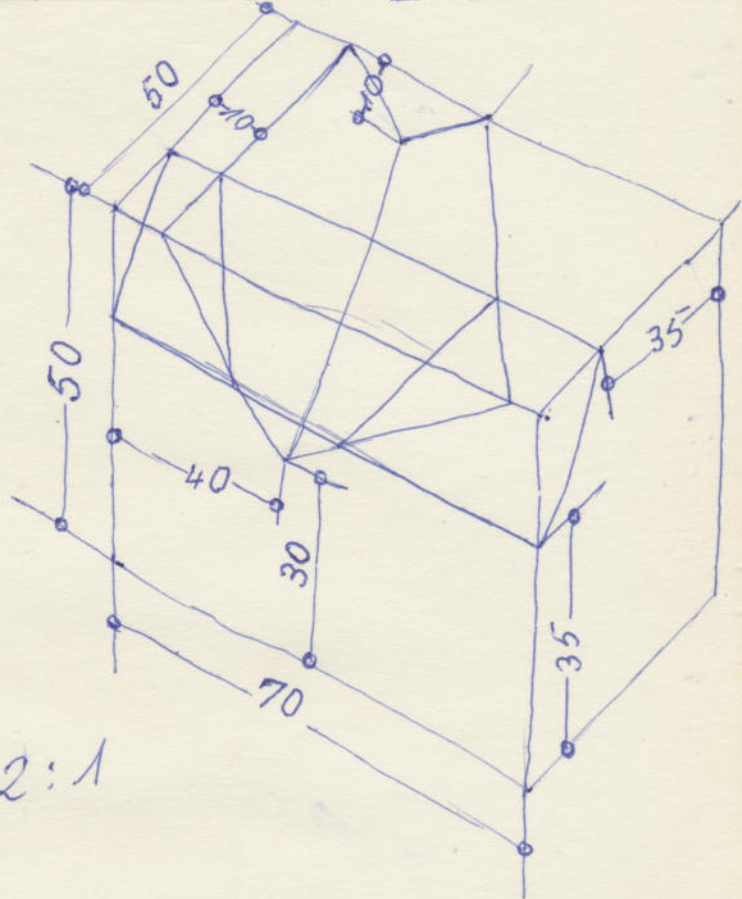
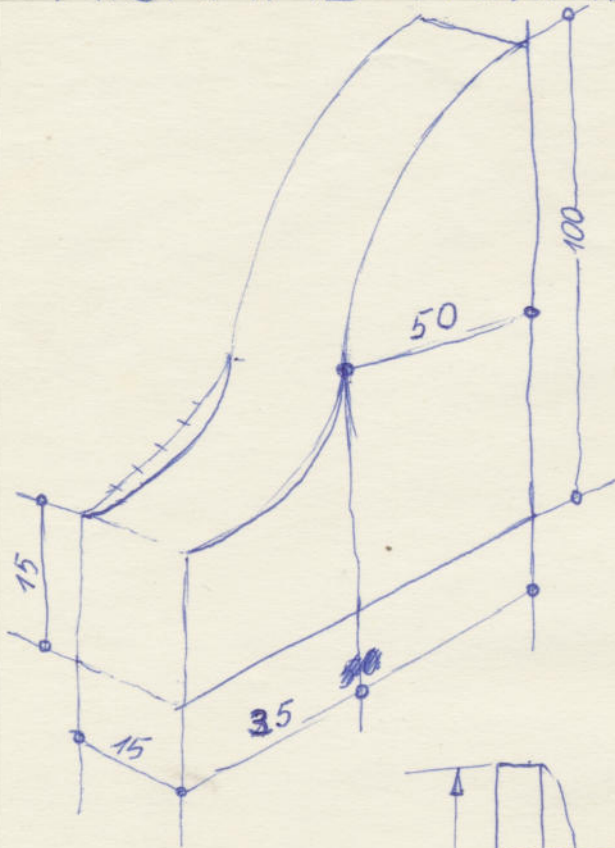

2:1

1:1

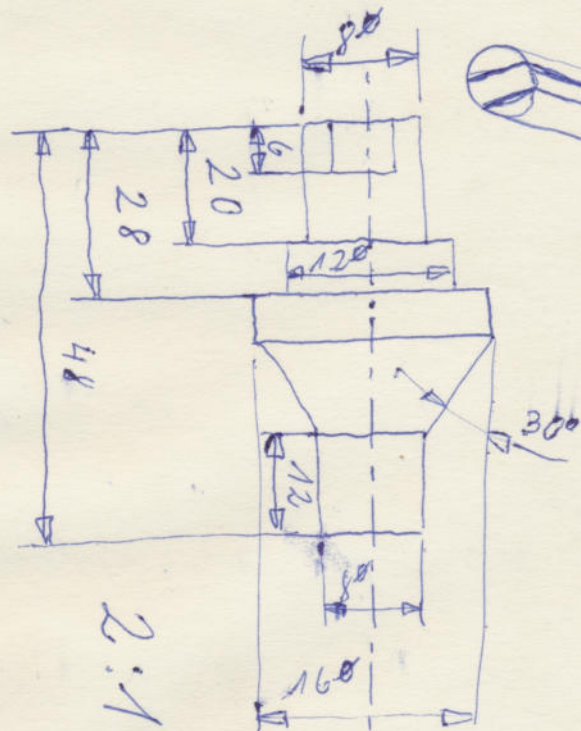
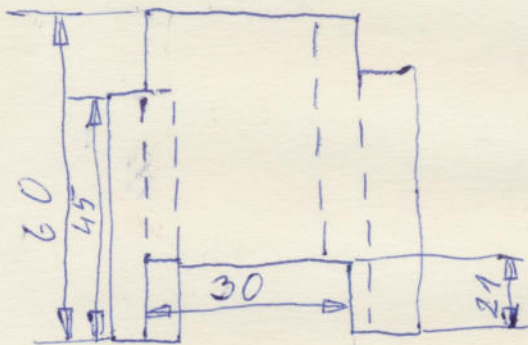
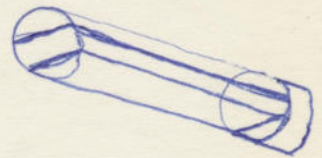
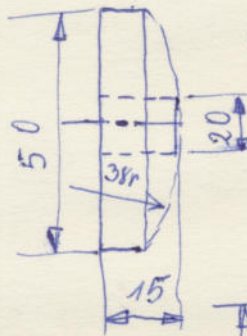

2:1

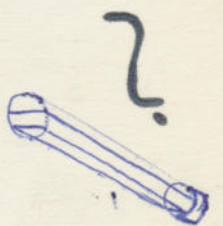
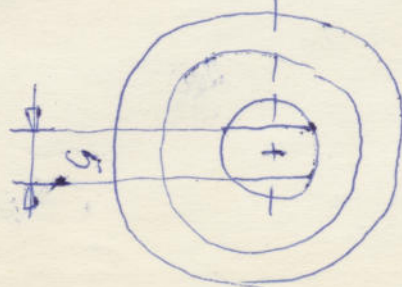
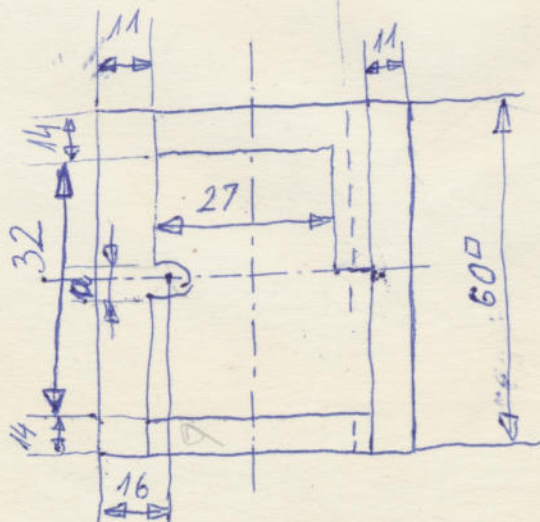

hk

RICHARD WIMMER N 1 B

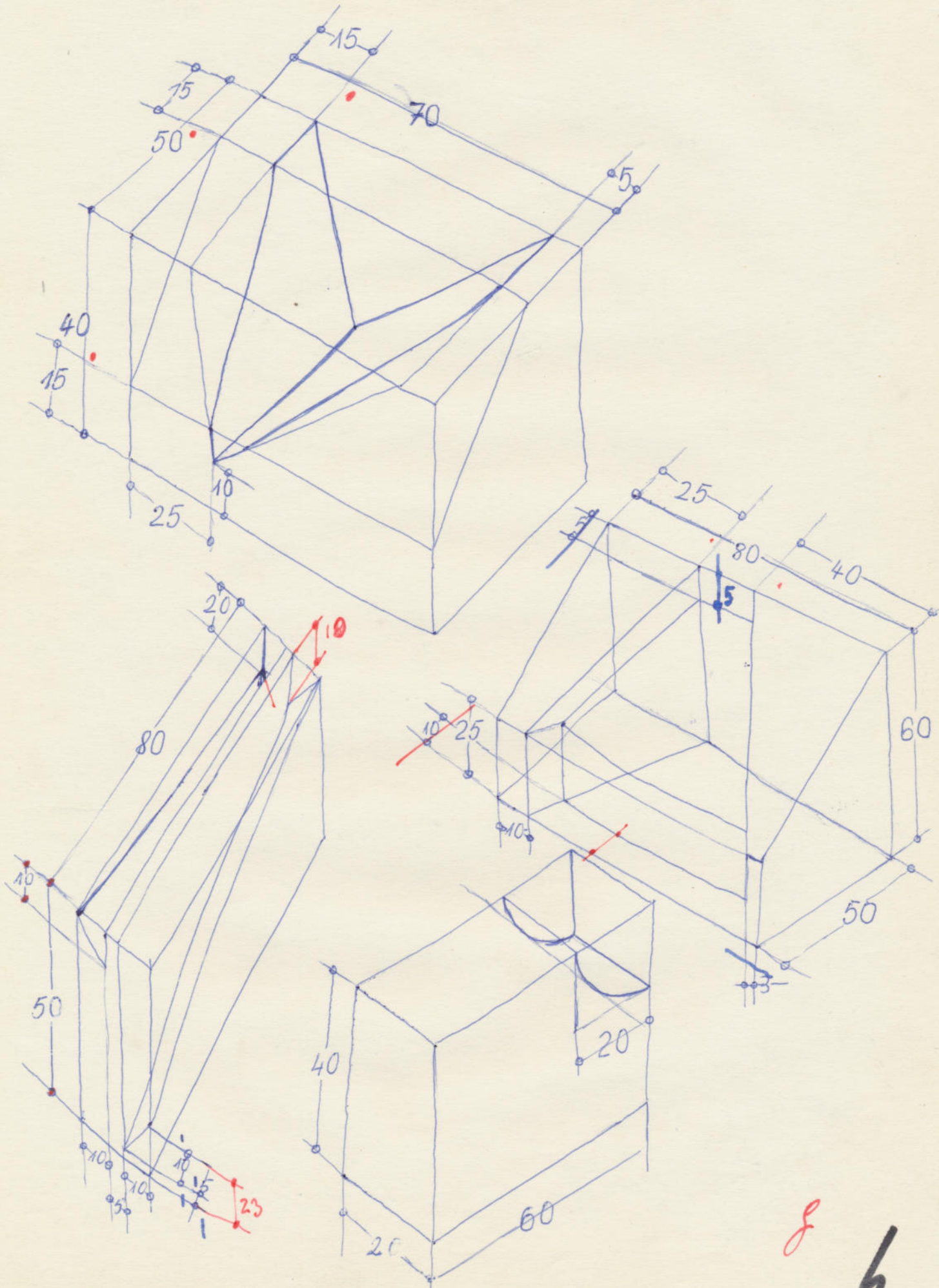

f h

Schnitt 33

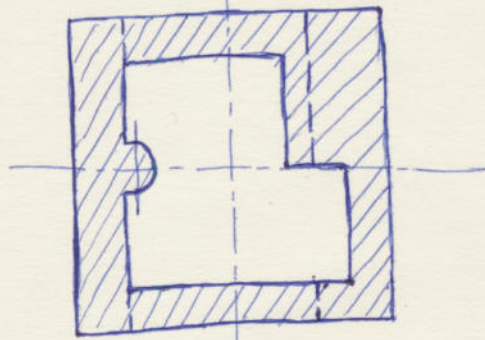

Schnitt 44

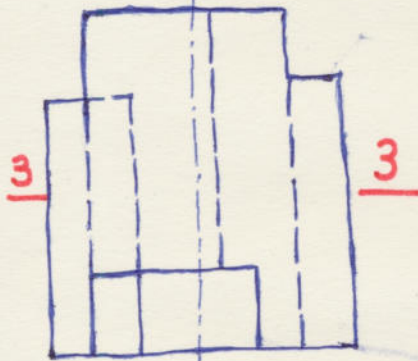
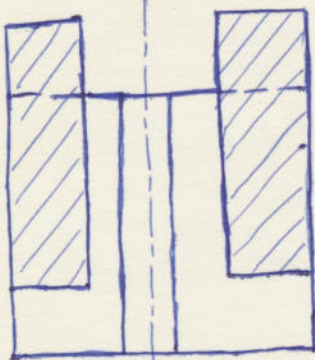

Schnitt 55

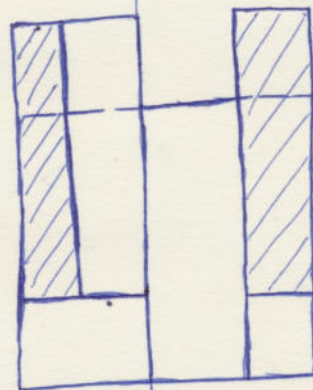

4/5

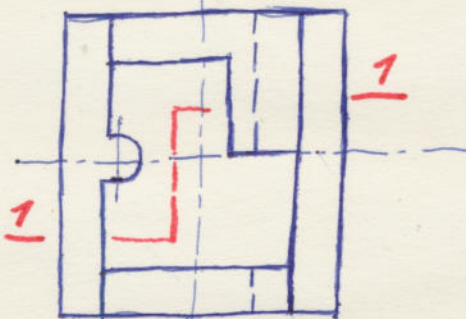
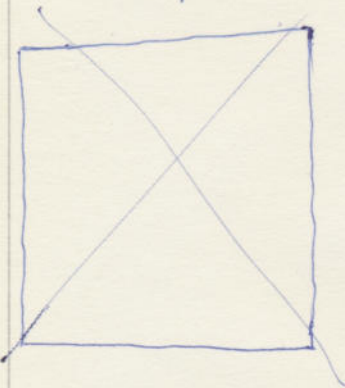

4/5

Schnitt 11

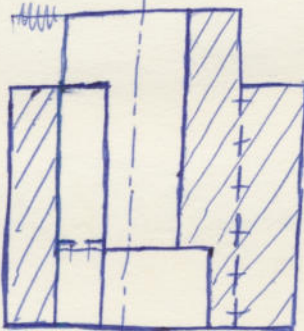

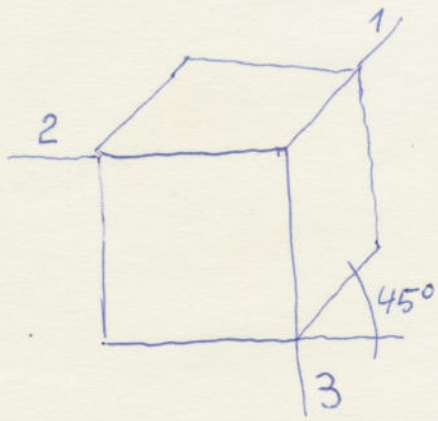

$$M2 = M3 = 1:1$$

$$M1 = \frac{M2}{2} = 1:2$$

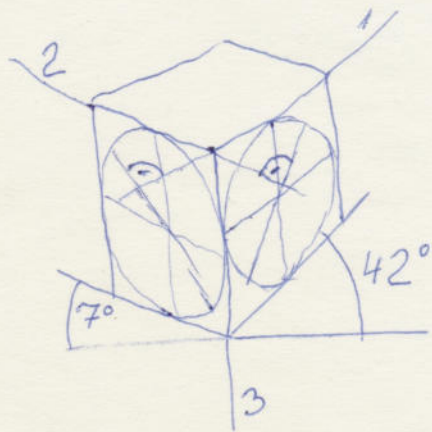

$$M2 = M3$$

$$M1 = \frac{M2}{2}$$

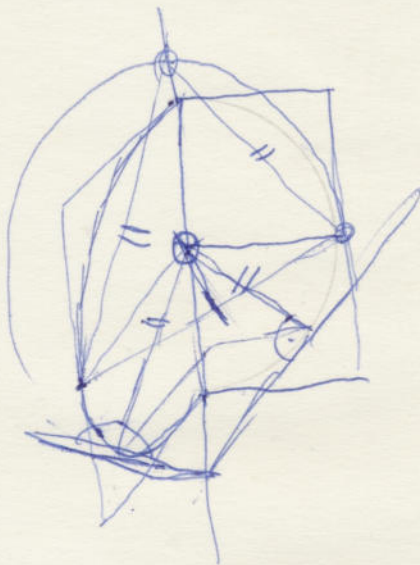
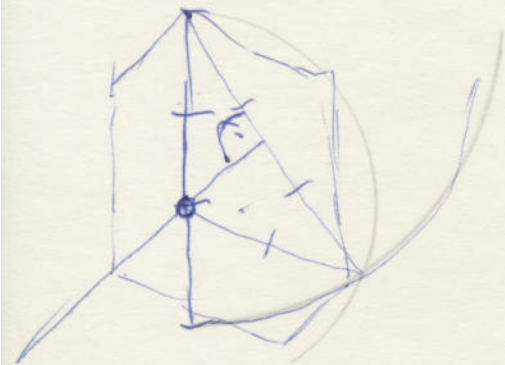

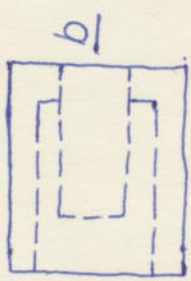
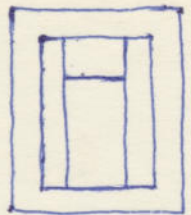

a

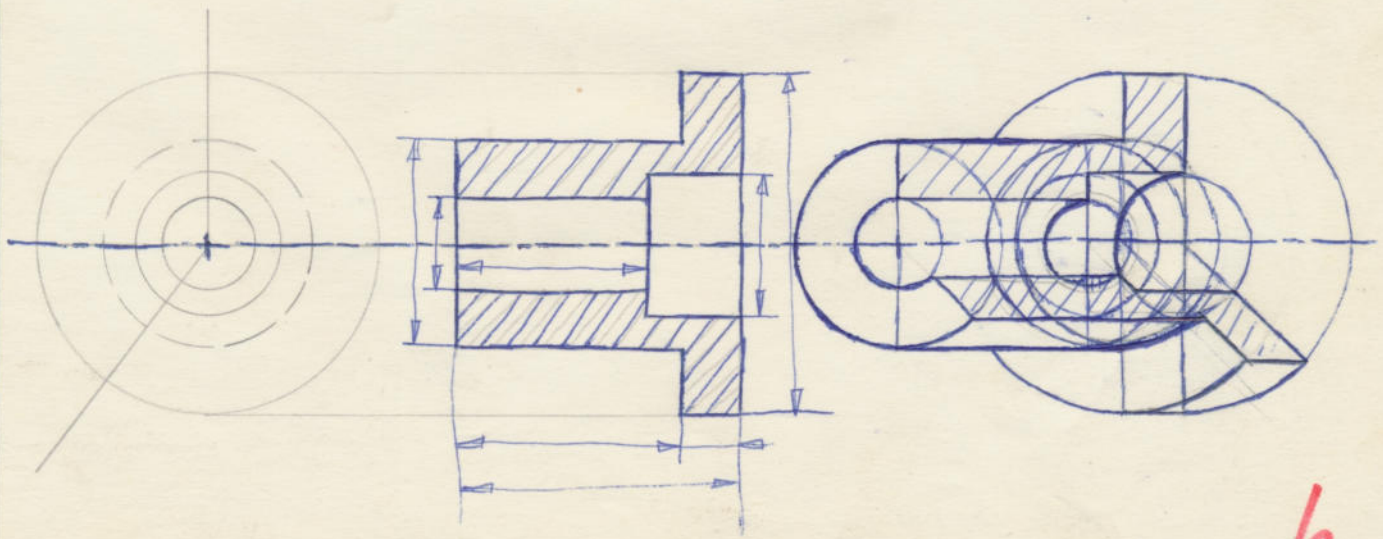
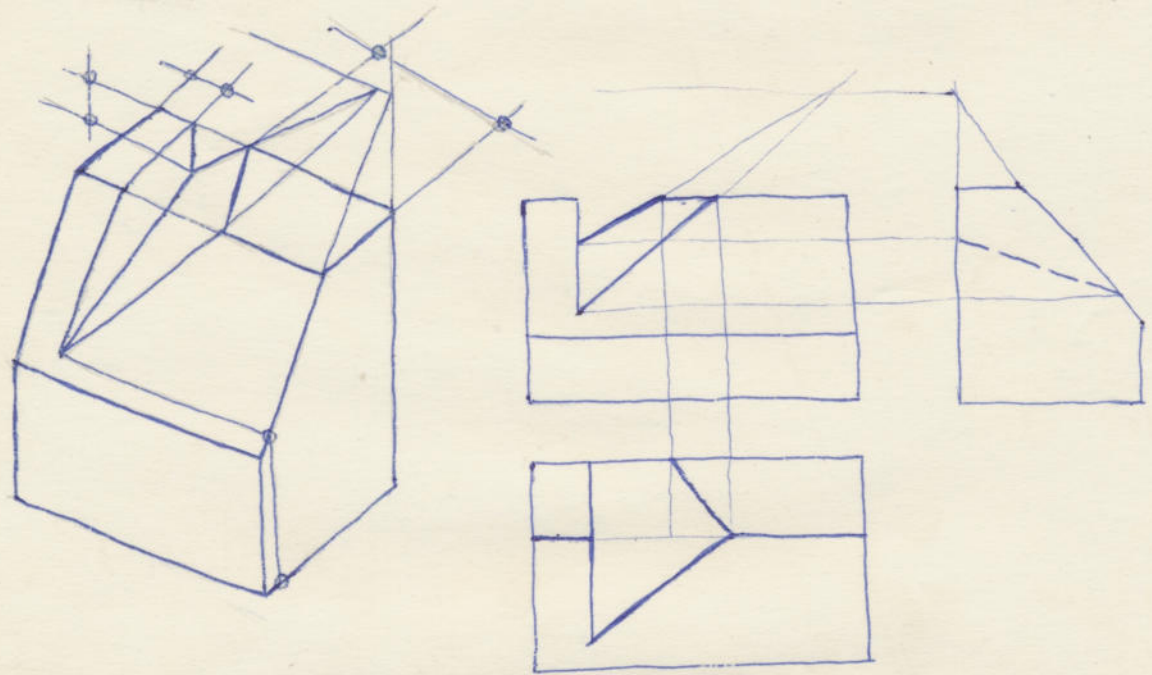

h



RICHARD WIMMER

N 1/B

$$M1 = M2 = M3 = (1:1)$$

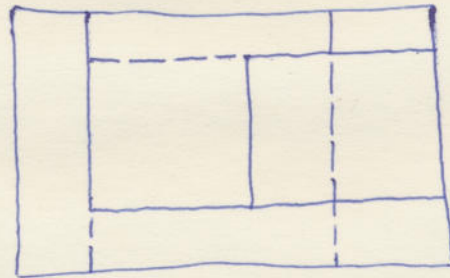
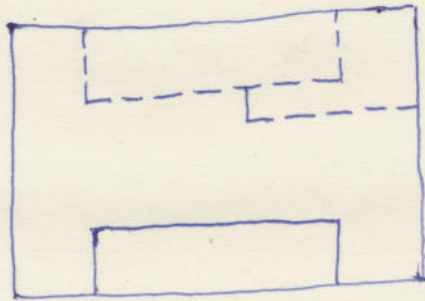
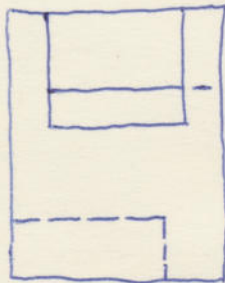
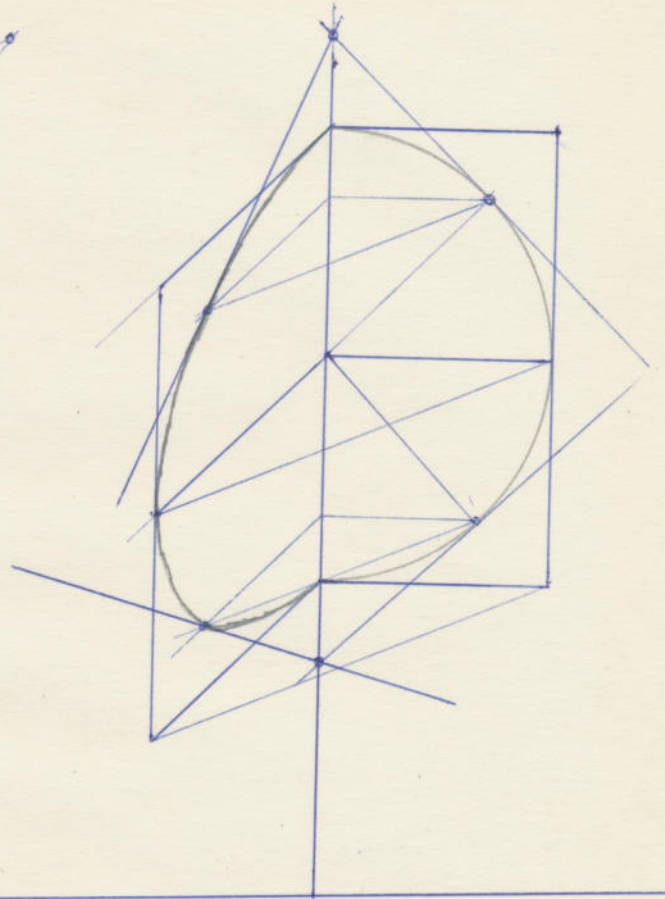
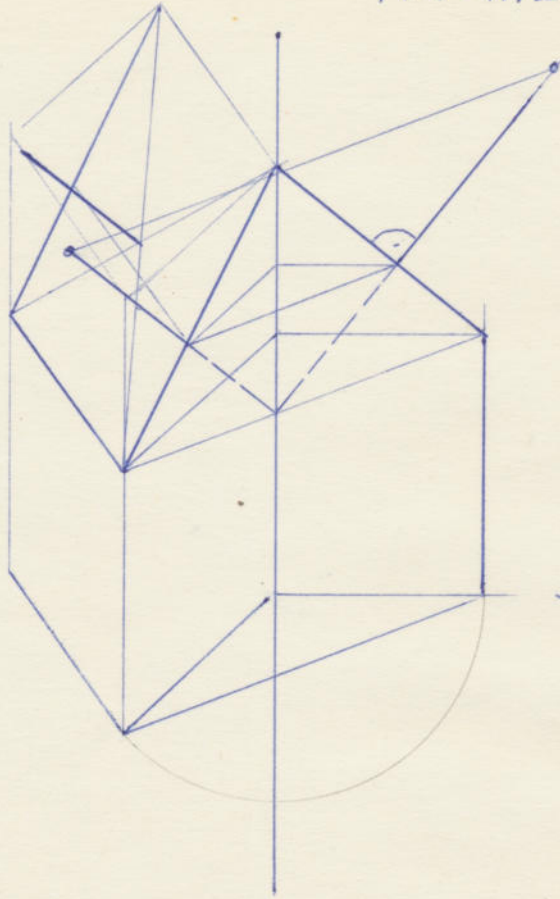

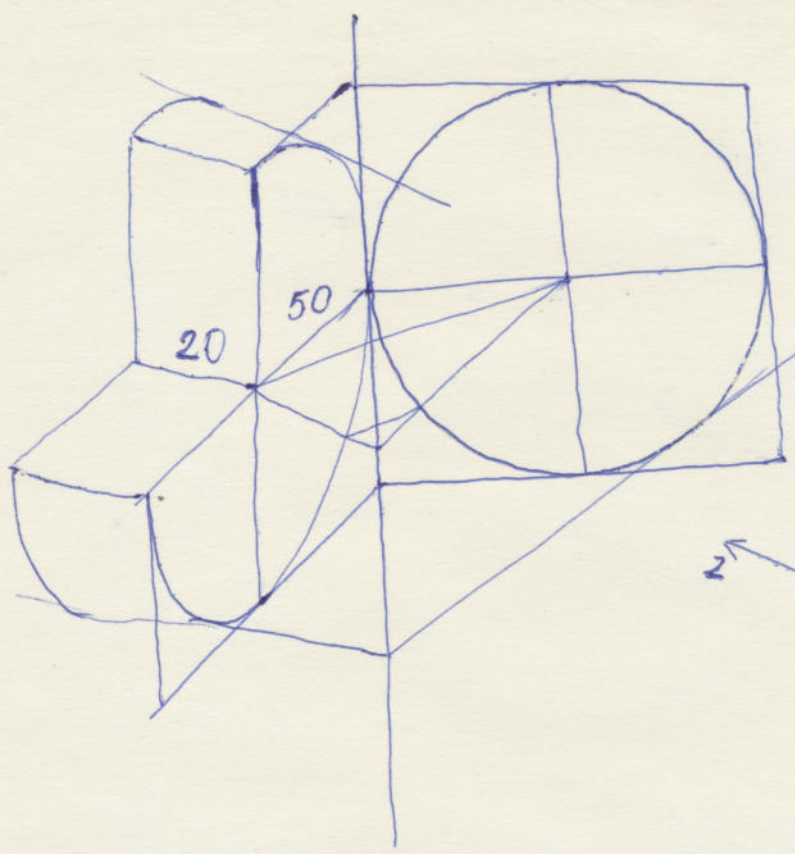

$\alpha_1 = 60^\circ$   
 $\alpha_2 = 160^\circ$   
 $\alpha_3 = -90^\circ$   
 $M_1 = \frac{8}{10}$   
 $M_2 = 1:1$   
 $M_3 = 1:1$

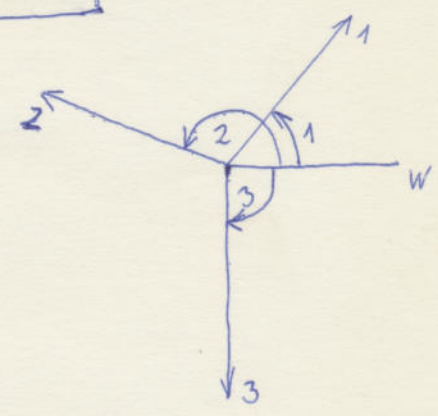

### NORMUNG

#### a) FORMATE

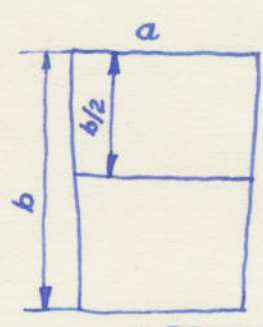

$a : b = \frac{b}{2} : a$

$2a : 2b = b : 2a$

$2b^2 = 4a^2$

$b = \sqrt{2} \cdot a$

$b = \sqrt{\frac{4a^2}{2}}$

$b = \sqrt{2} \cdot a$

$b \cdot a = a^2 \cdot \sqrt{2} = 1000000 \text{ mm}^2$

$a = \sqrt{\frac{1}{\sqrt{2}}}$

$a = 841 \text{ mm}$



$A0 = 841 \times 1189$

•  $A1 = 594 \times 841$

•  $A2 = 420 \times 594$

•  $A3 = 297 \times 420$

\*  $A4 = 210 \times 297$

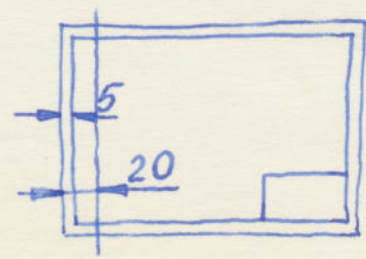

RICHARD WIMMER

4/IV  
N 1/B

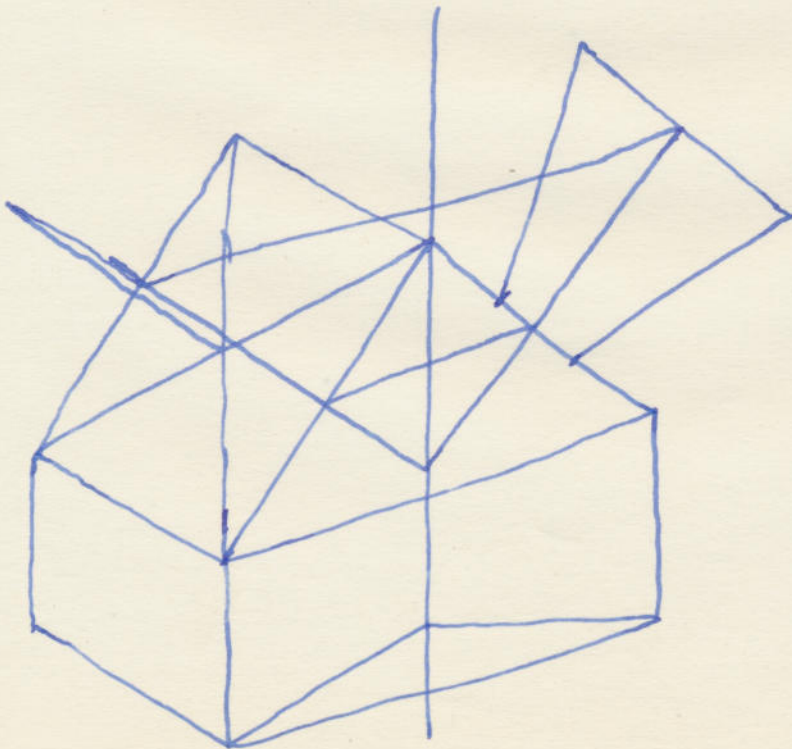
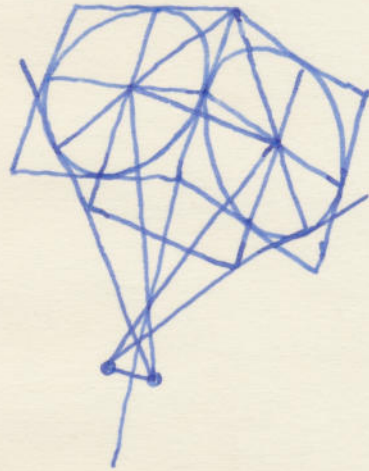
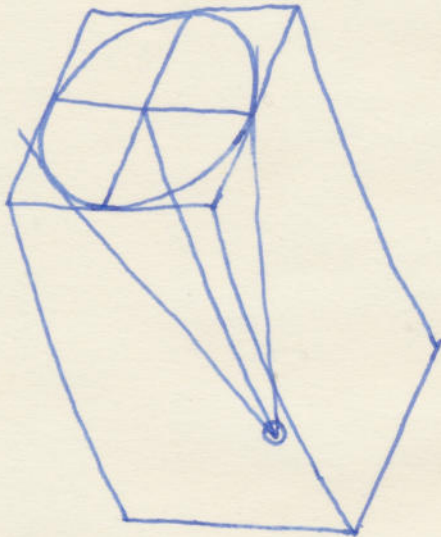
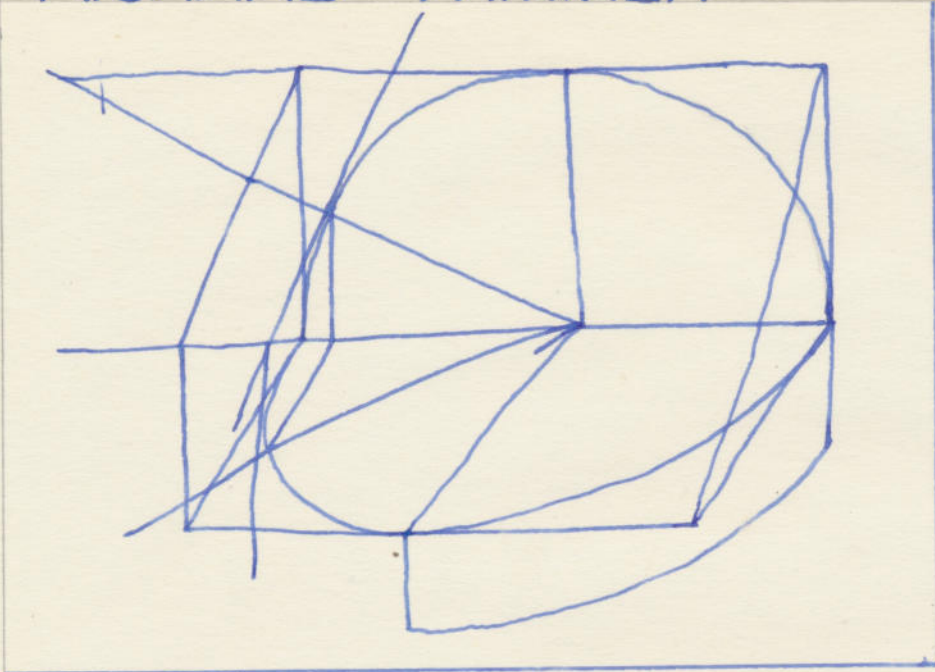

h

Papierfaltung

1.) Schablonen

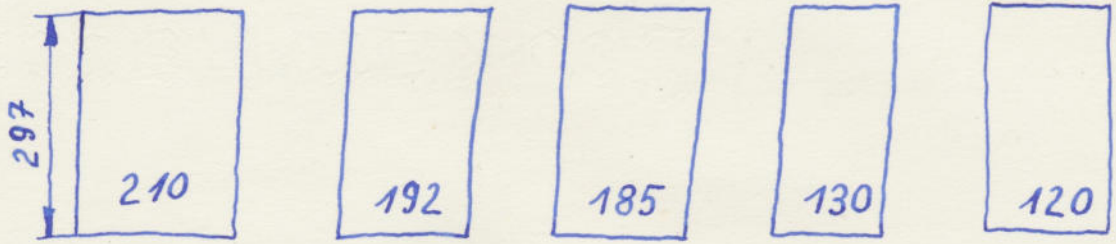

2.) Faltprinzip

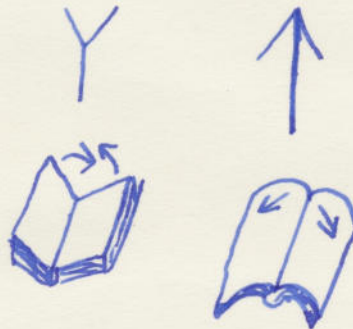
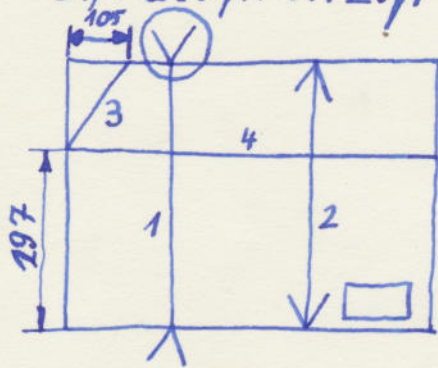

Reihenfolge

- 1
- Serie 2
- 3
- 4 Umfaltung

3.) FALTSCHHEME

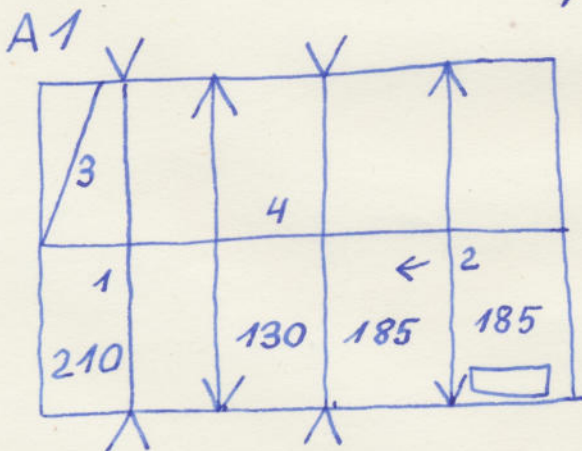
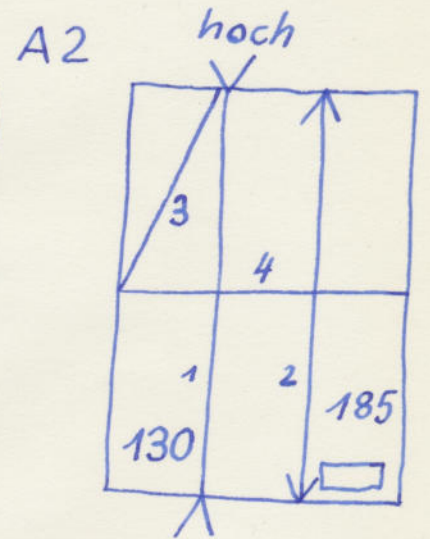
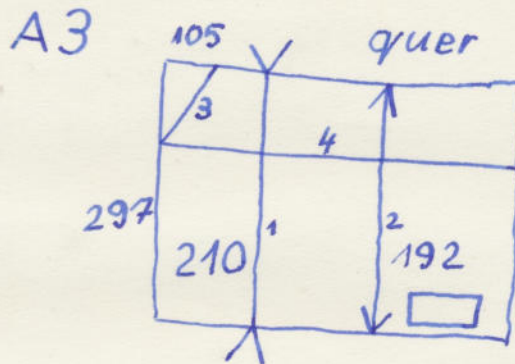
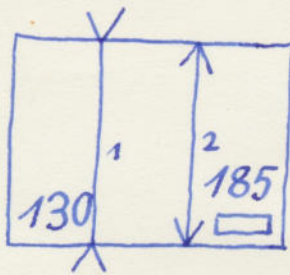

A0

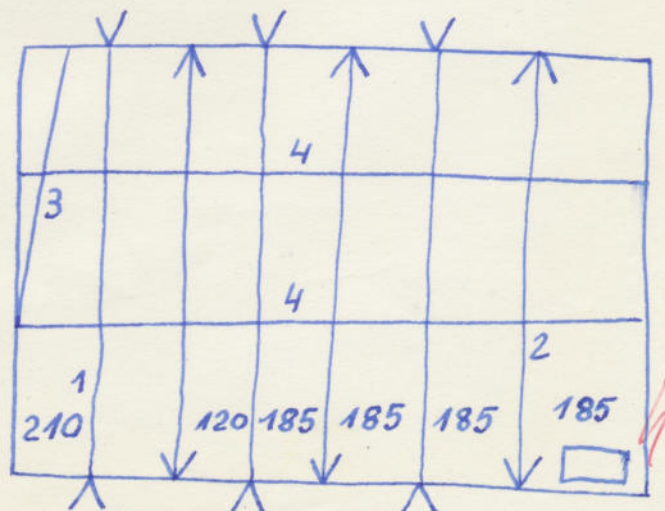

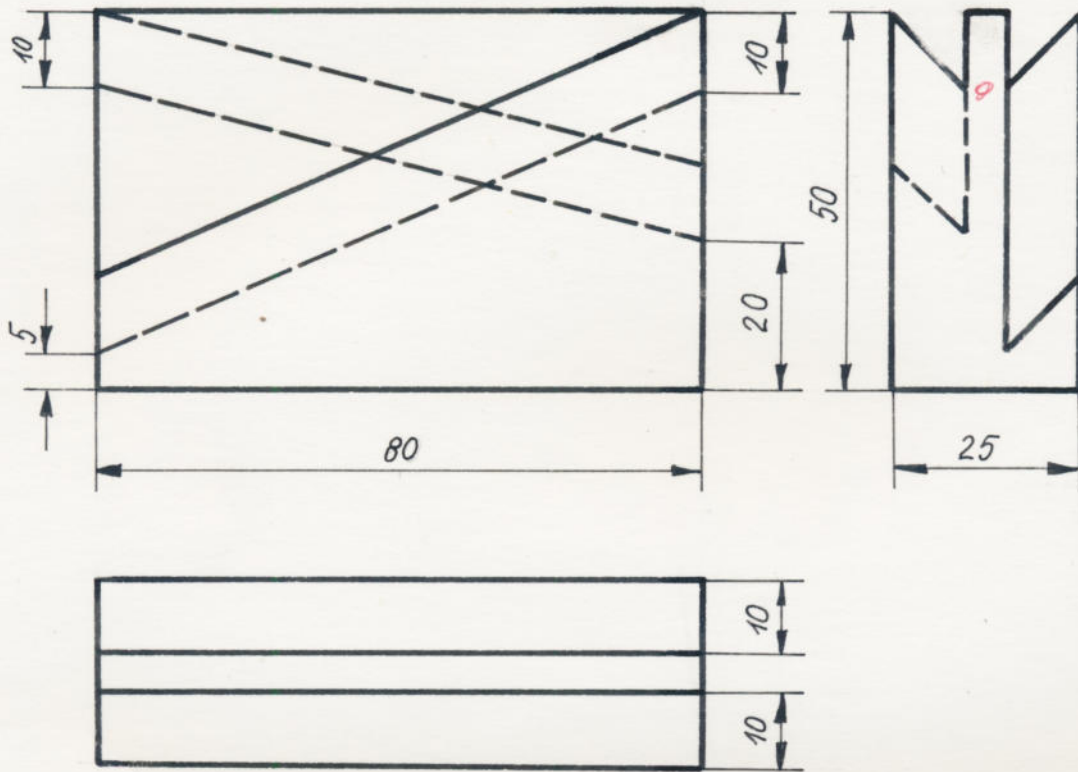

Bem. instruktiver  
Anordnen

RICHARD WIMMER N1B

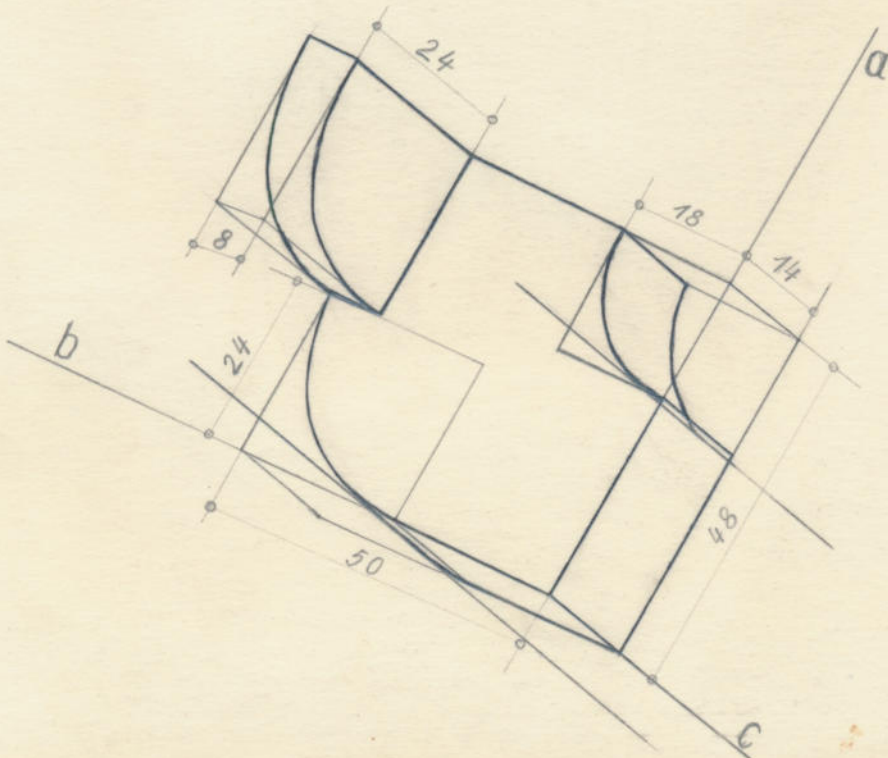
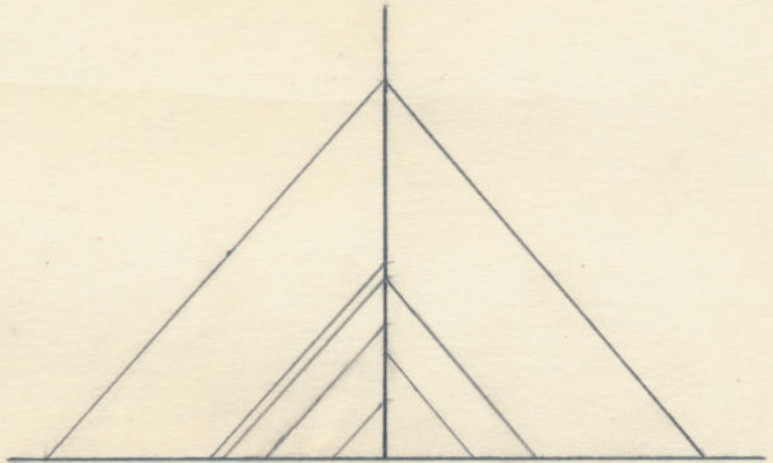
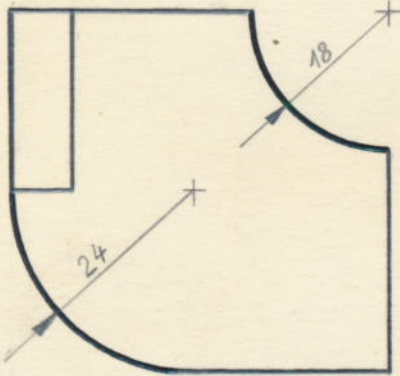
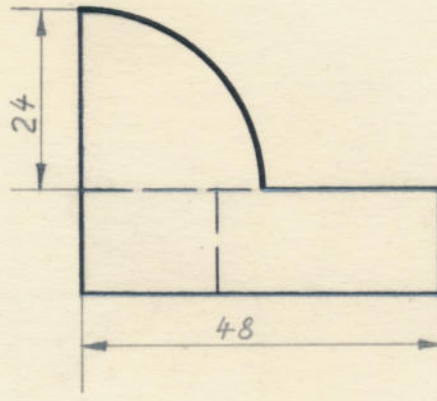
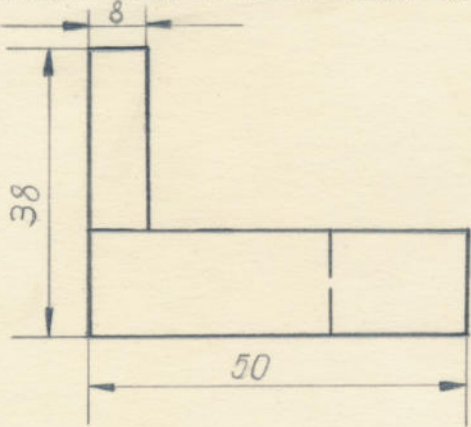

h

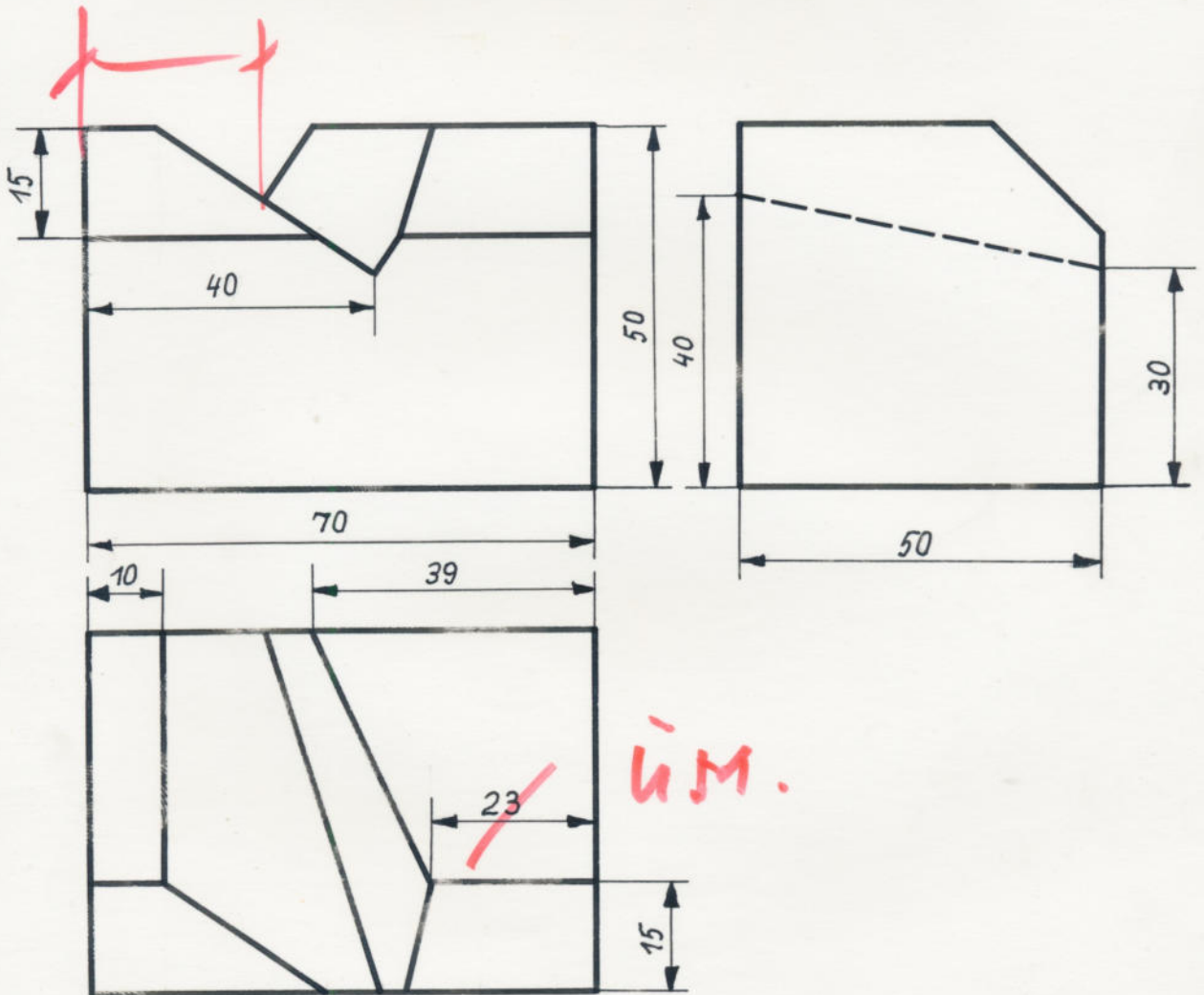

2:1

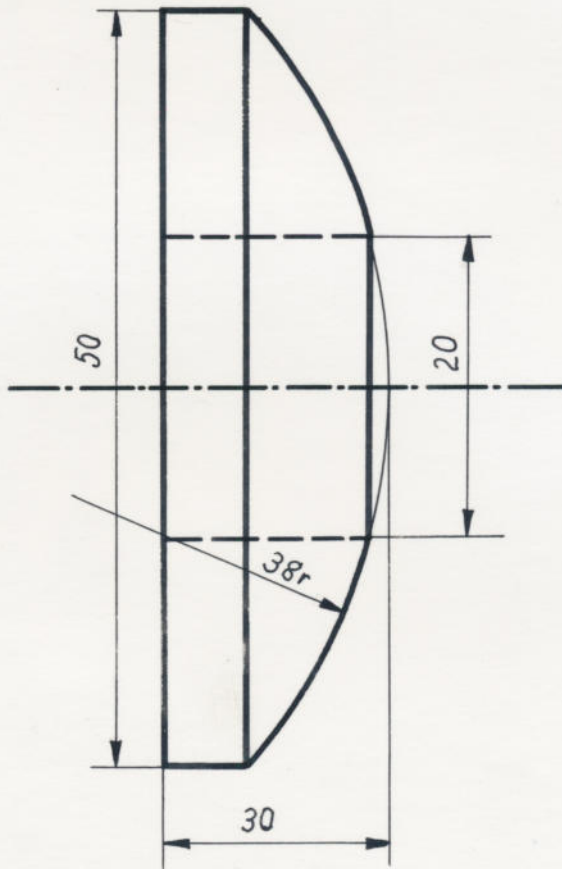

18 h



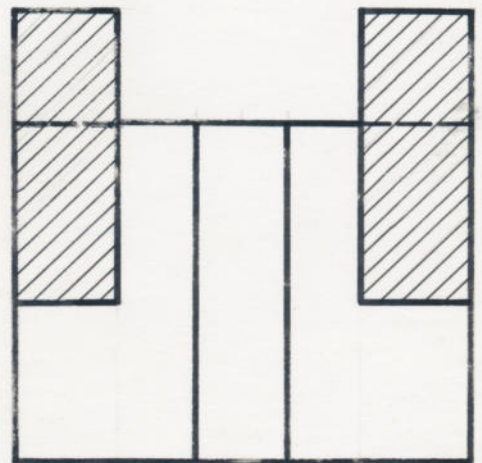
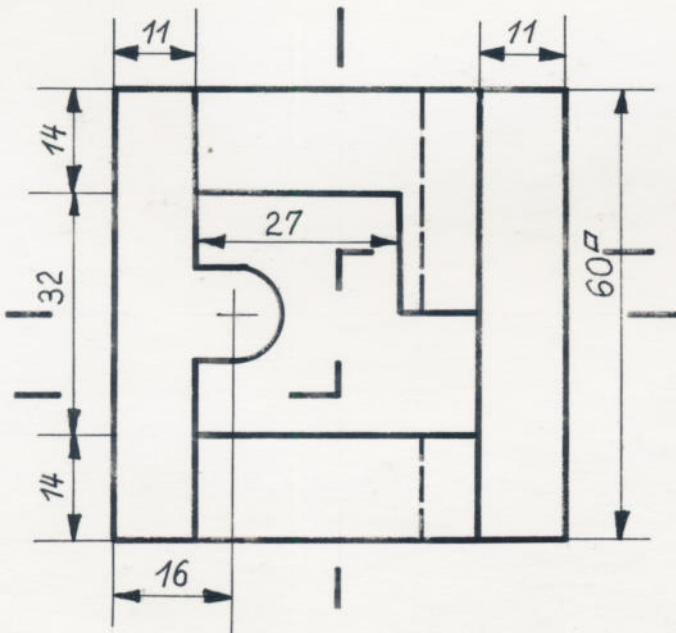
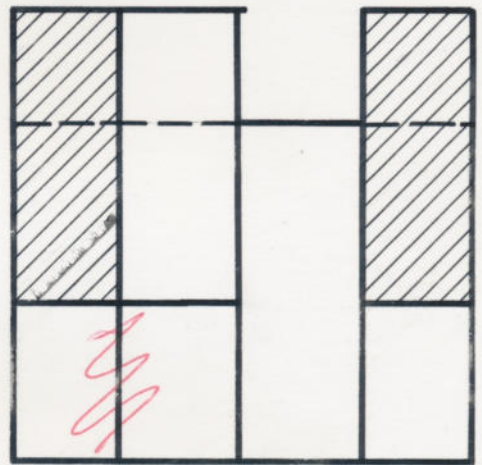
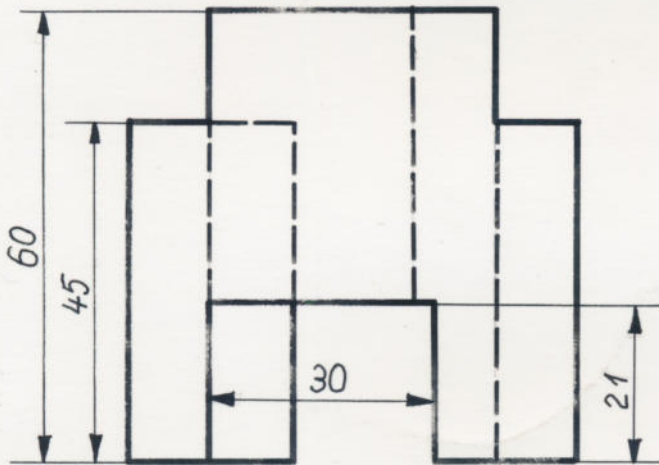
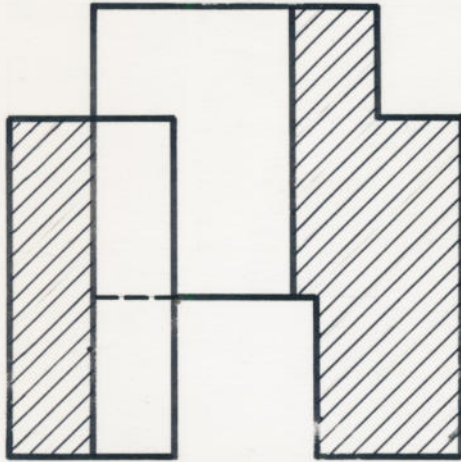

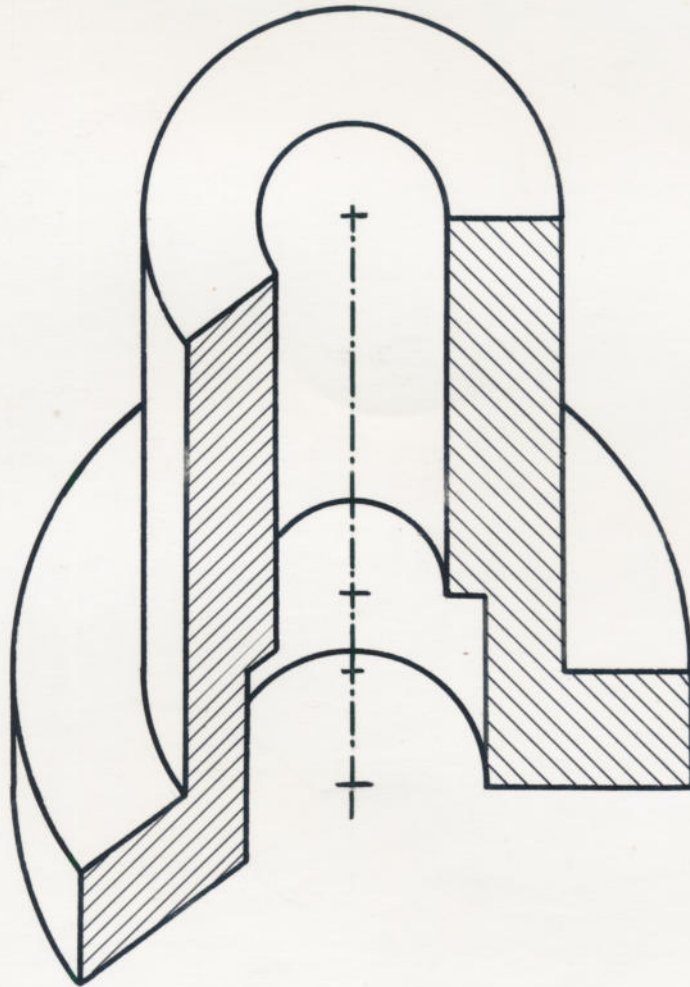
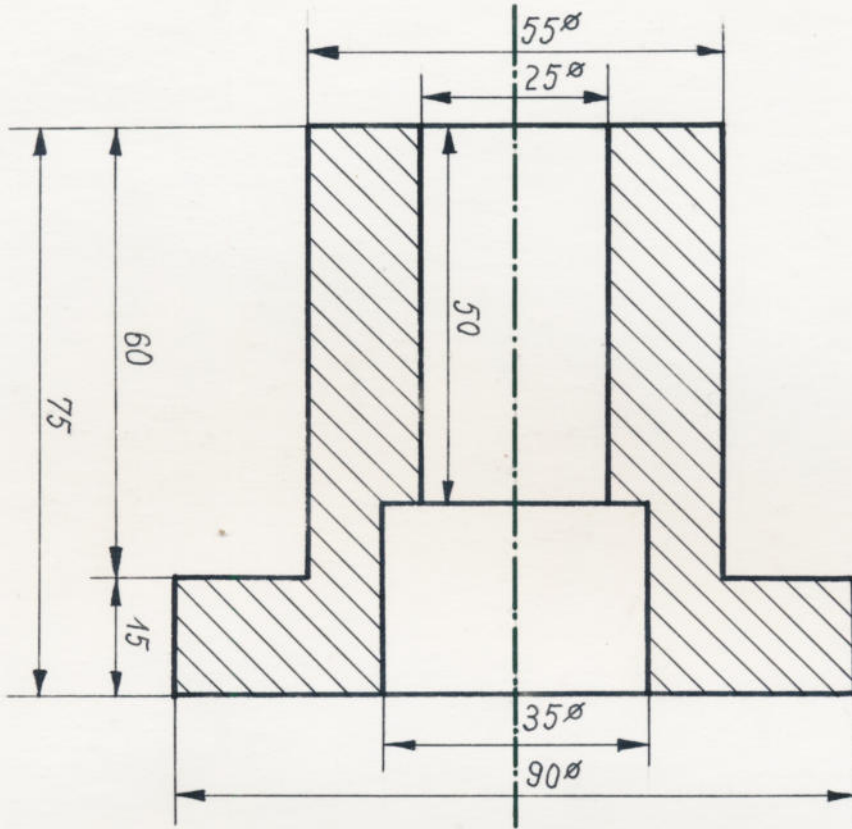

MODELL 48

4

23

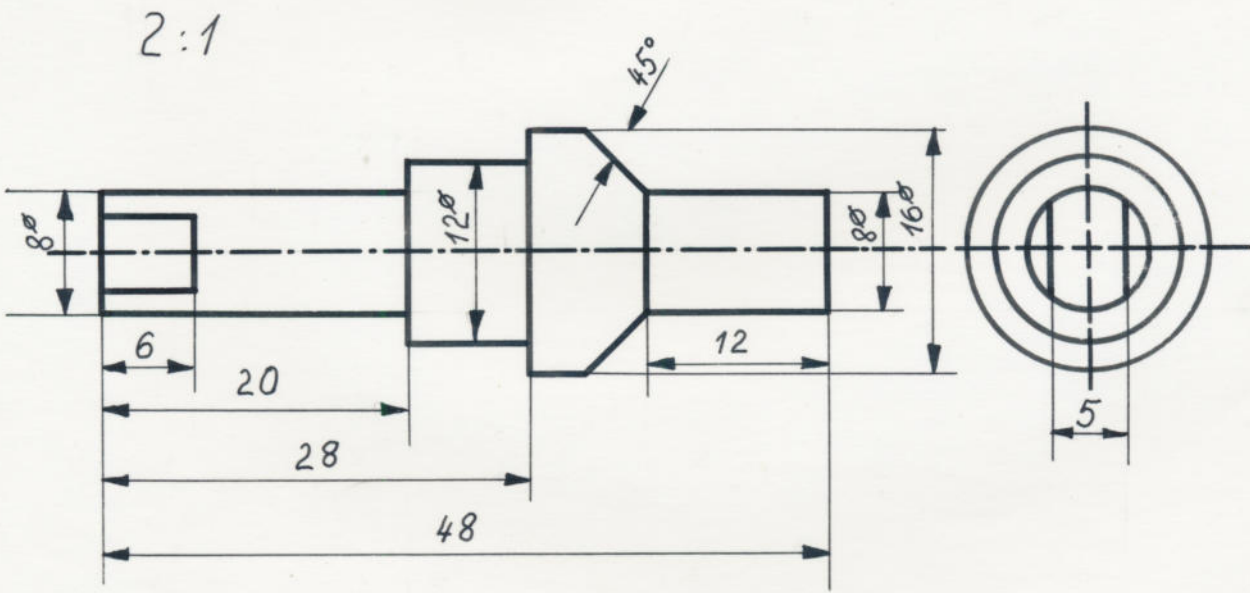

25 h



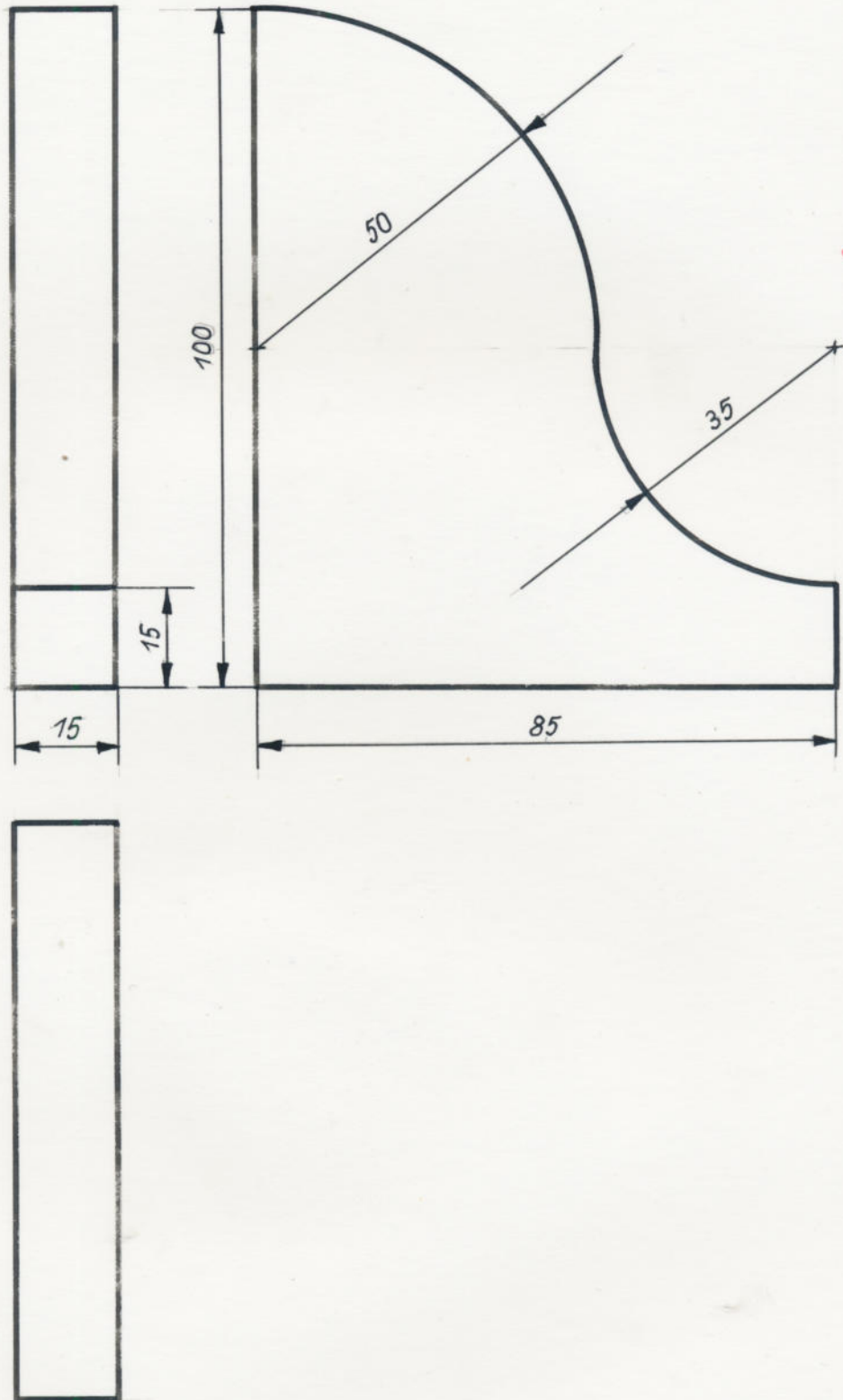

X

h



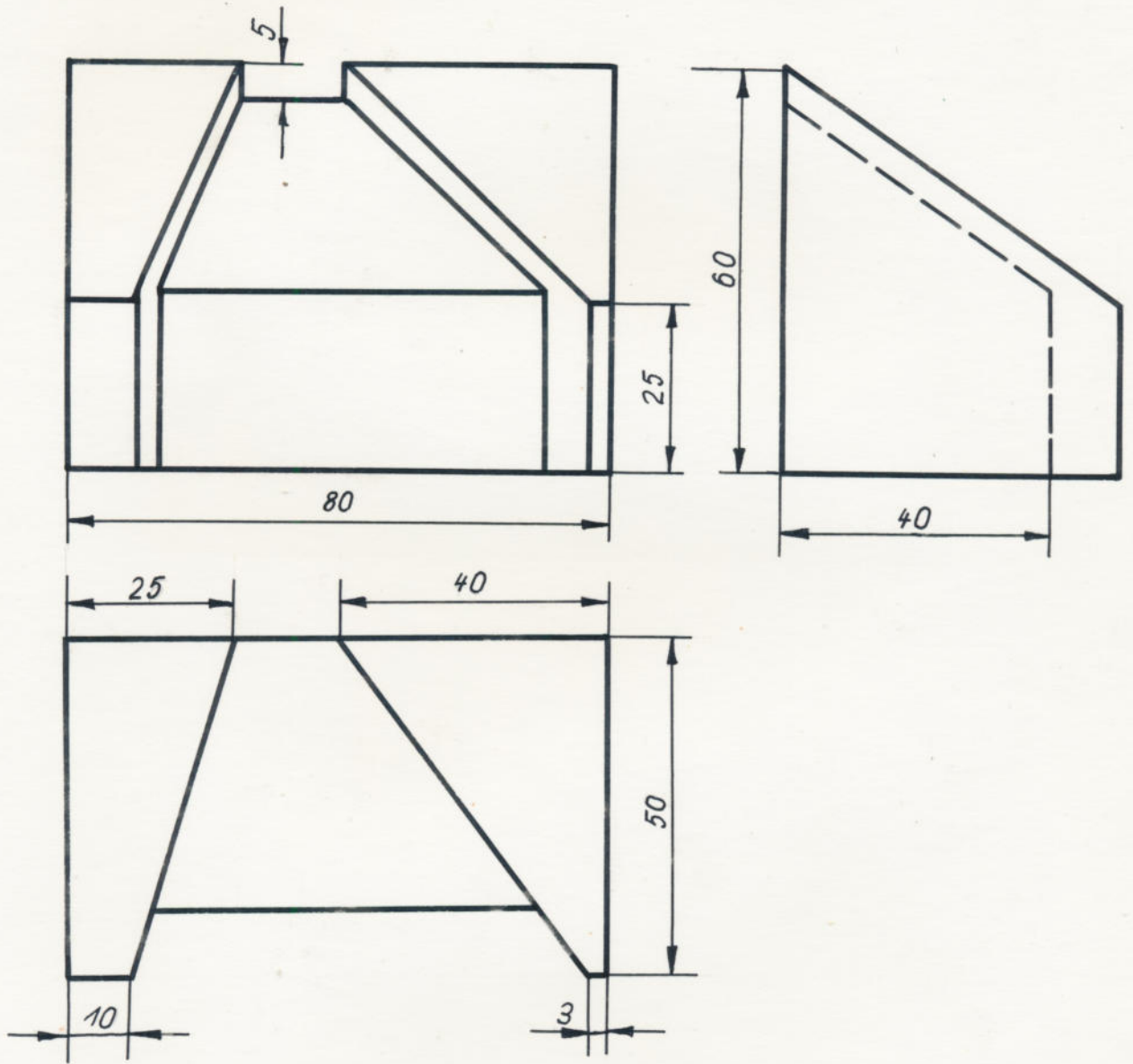

h



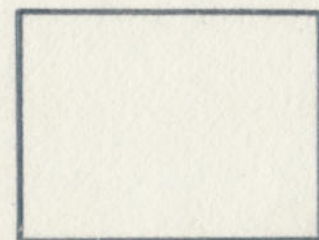
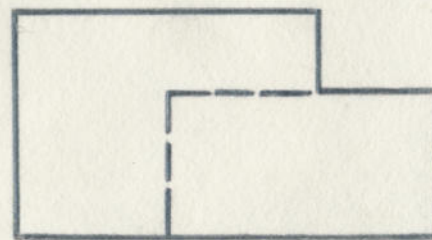
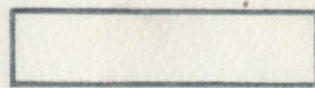
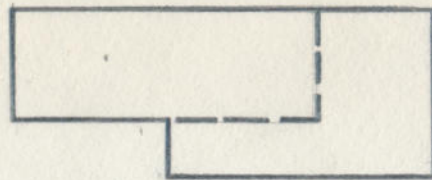
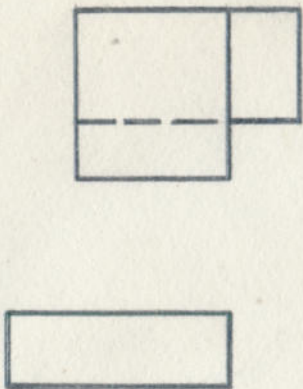
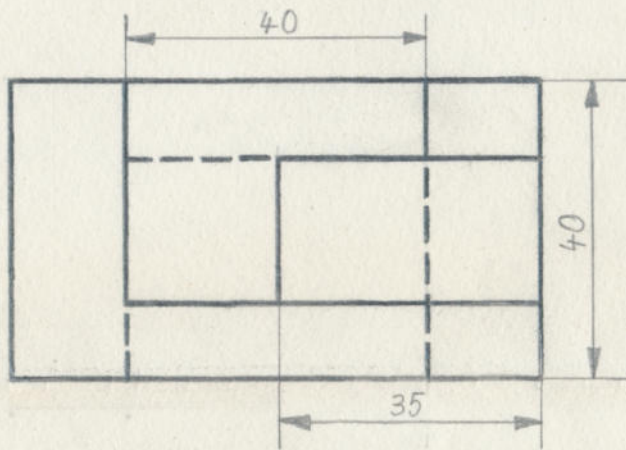
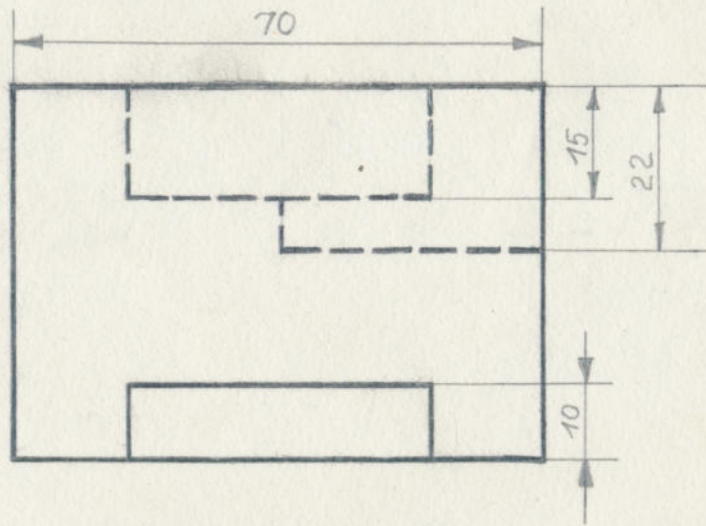
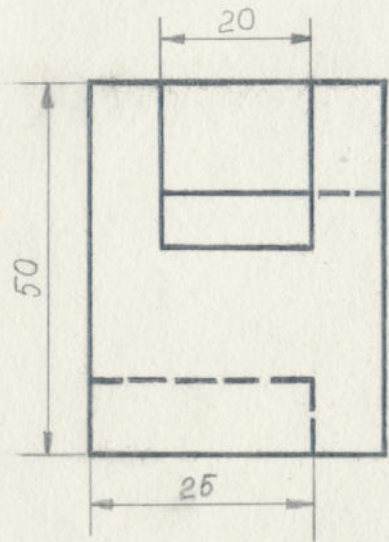

9

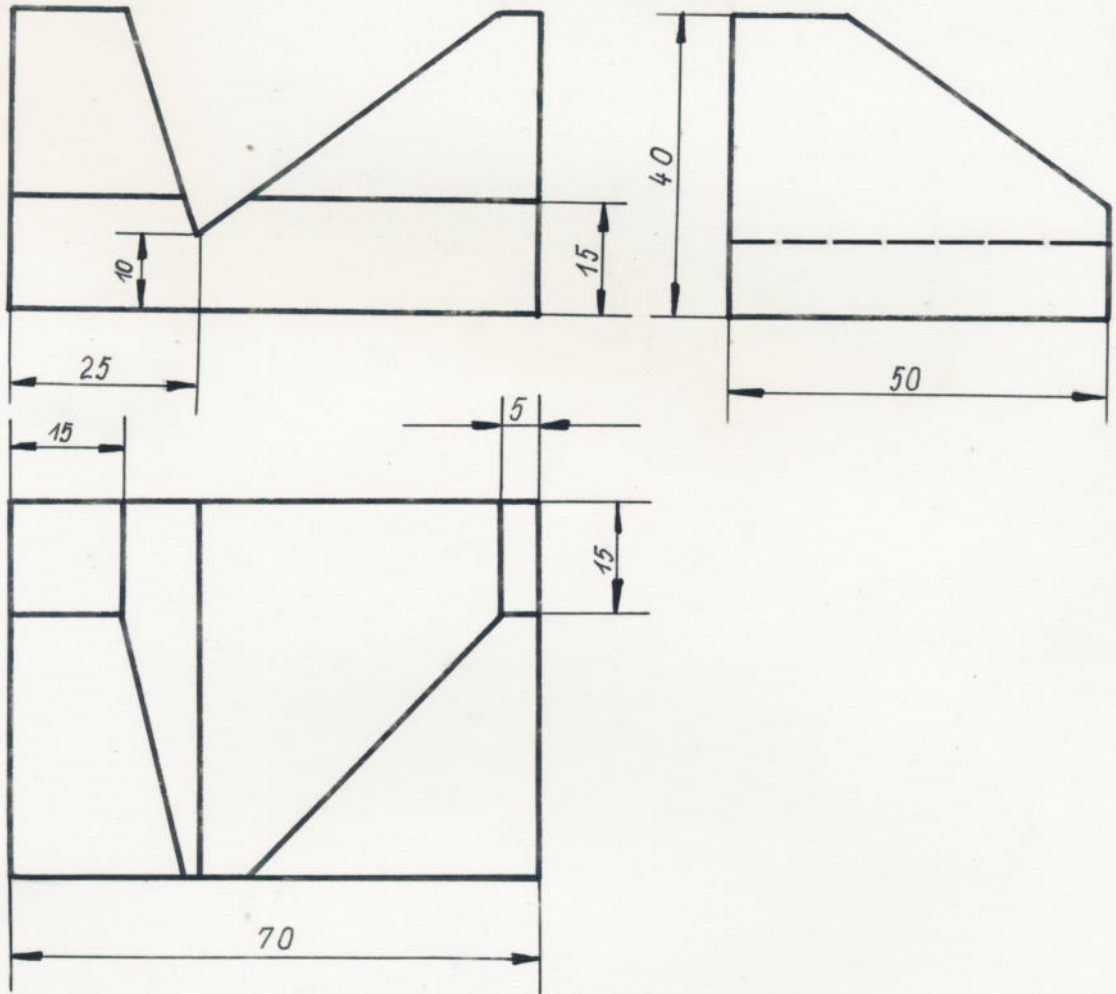

h



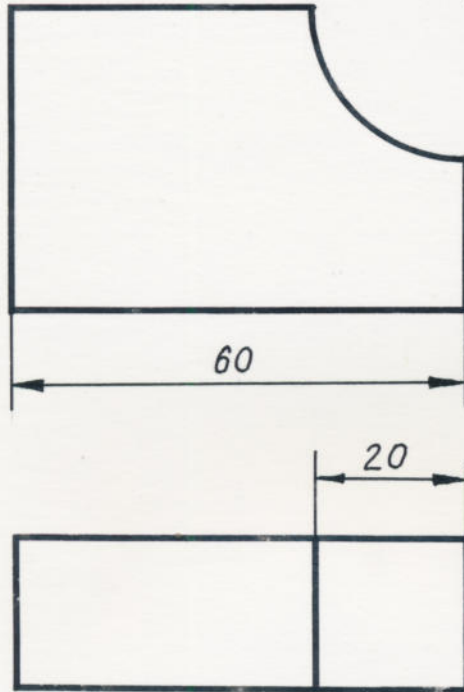

h

h



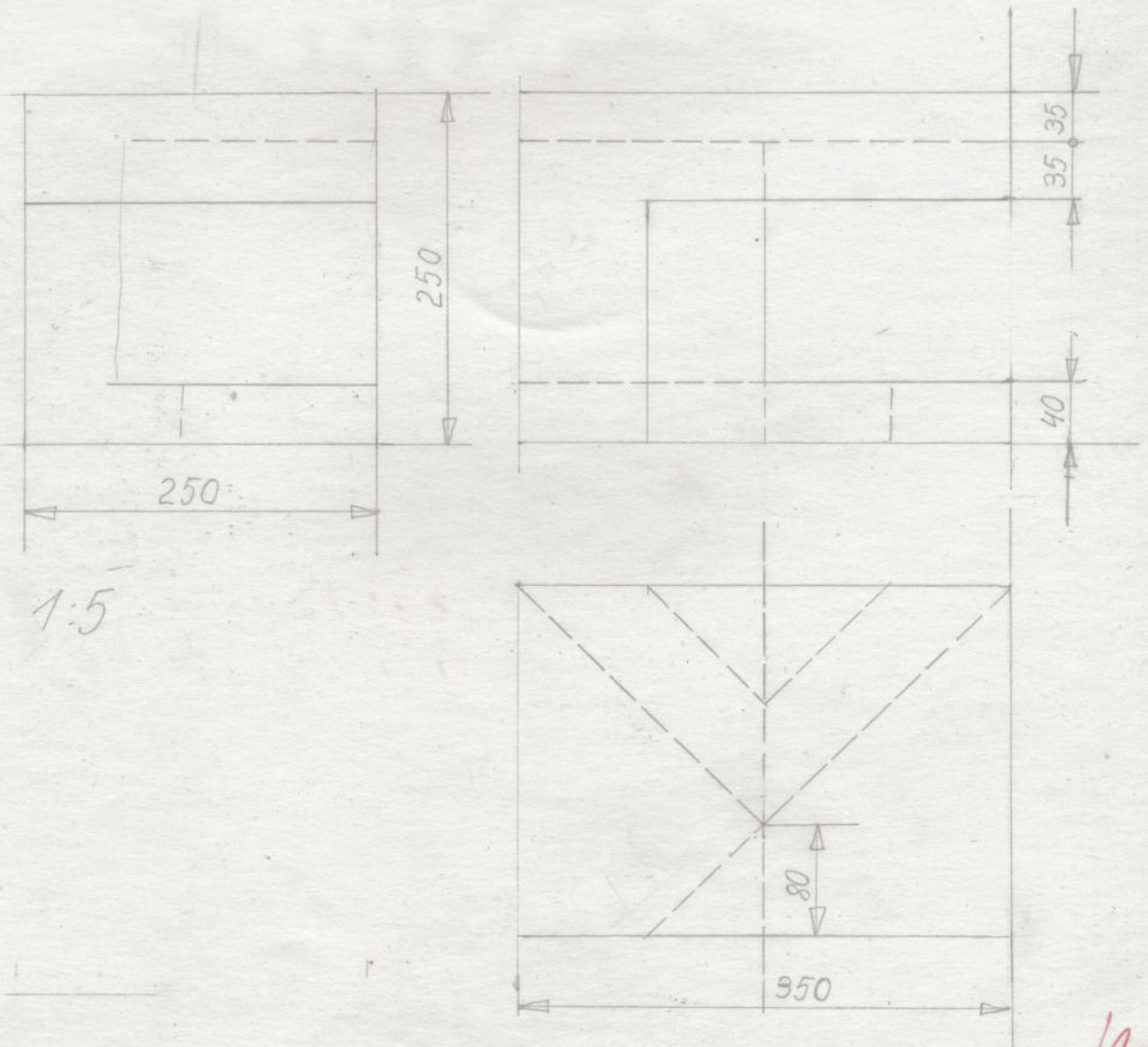

4

